

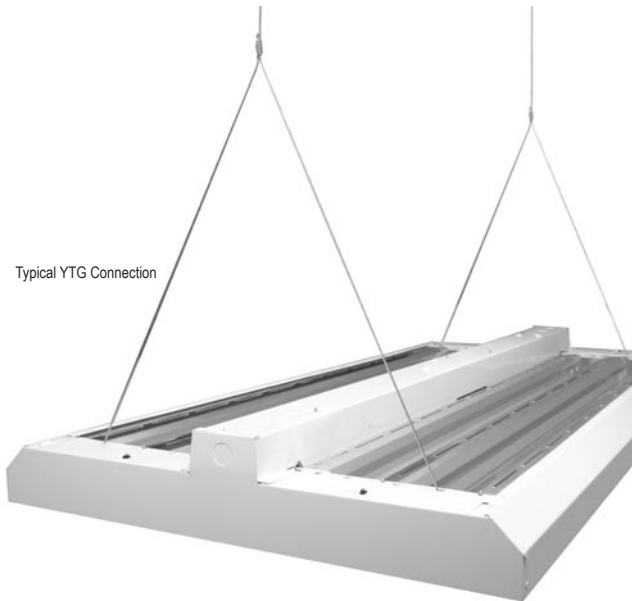

Catalog Number:

Type:

Aircraft Cable Mounting Accessories



Typical YTG Connection

Note: All luminaires do not necessarily accommodate all cable end types.



Single Toggle (TG)



Two Toggles (YTG)



Loop End (LP)

Family Description

MH

Cable End Type

TG Single Toggle 5/16" Wide
 YTG Two Toggles, 5/16" Wide, 18" legs
 LP Loop End

Cable Size

B 5/64"

Length

10 10'
 ## * Length in Feet

Specifications

Industrial Aircraft Hangers are extremely quick and easy to install. No special tools or skills are required for installation. One of the great benefits of the system is the speed and flexibility of installation.

Aircraft cables are provided in kits (two cables per kit), so one kit is needed per fixture ordered. Each of the cables includes one hanger.

Cable kits are pre-packed in boxes of 5, 25 & 50 and they must be ordered in these multiples.

NOMENCLATURE				PERFORMANCE SPECIFICATION			
FAMILY DESCRIPTION	SUPPORT END	CABLE SIZE	LENGTH (FT.)	CABLE DIAMETER (INCHES)	WORKING LOAD (LBS)	MINIMUM BREAKING LOAD (LBS)	LOAD PERCENTAGES (DEGREES)
MH	LP	B	10	5/64"	23 - 100	500	0° AT 100% 15° AT 96% 30° AT 86% 45° AT 70% 60° AT 50%
			30	5/64"	23 - 100	500	
	TG	B	10	5/64"	23 - 100	500	
			5	5/64"	23 - 100	500	
	YTG	B	10	5/64"	23 - 100	500	
			15	5/64"	23 - 100	500	

* Longer lead-times for custom lengths. Consult factory for availability.



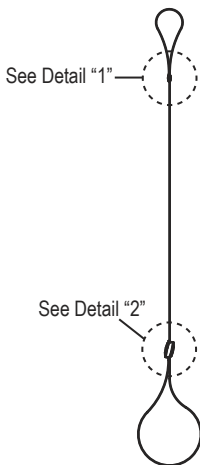
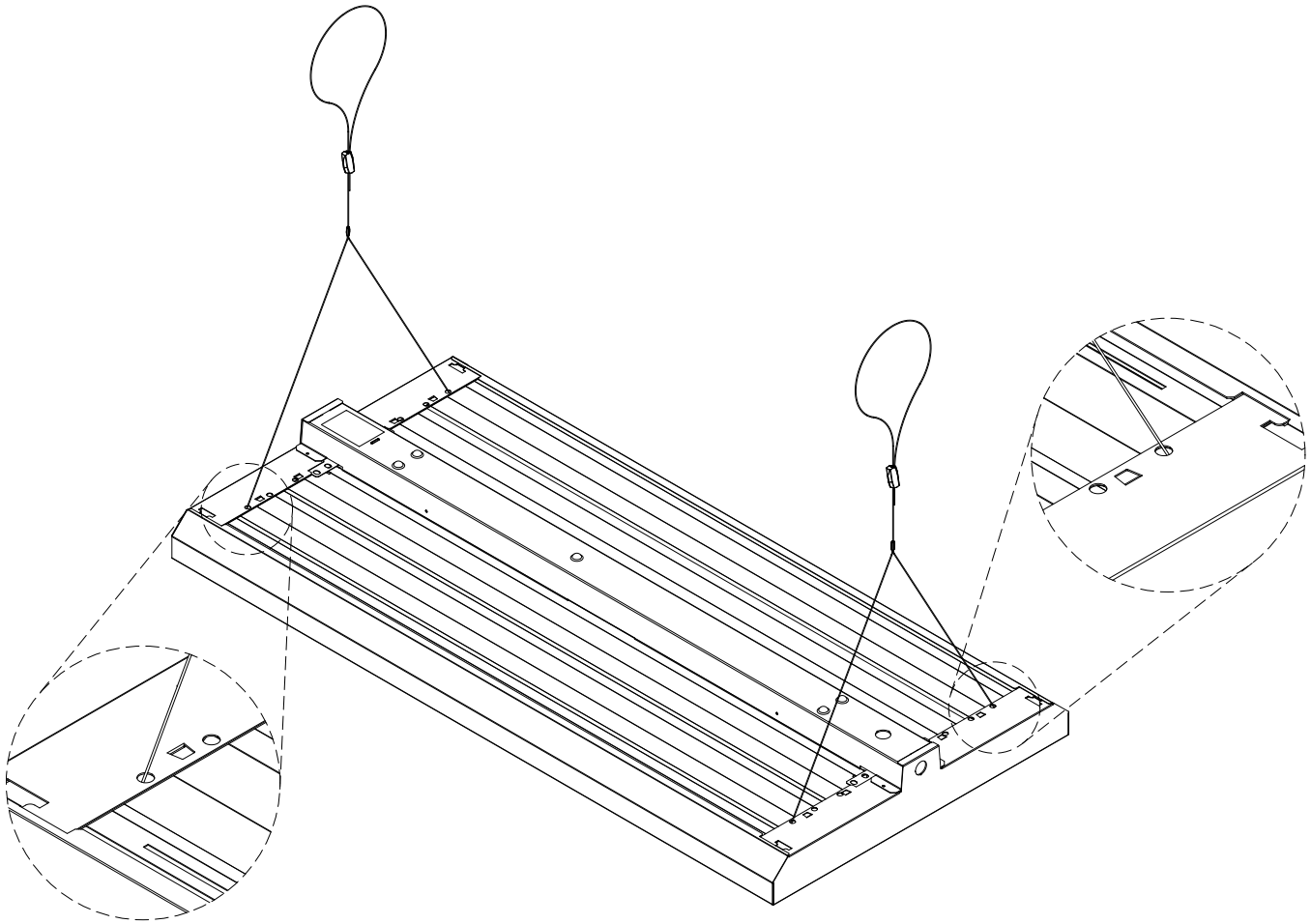

Double Loop with One Loop Adjustable (MHLP)

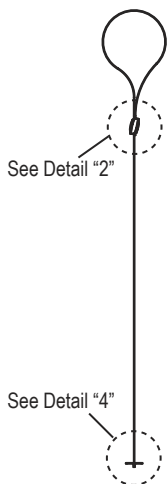

Single Adjustable Loop with toggle (MHTG)

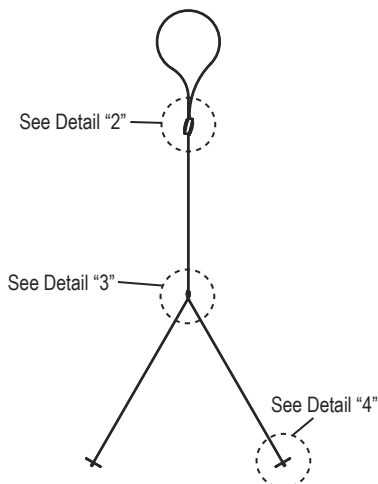

Single Adjustable Loop Y with toggle (MHYTG)



Detail "1" Swedged Connection

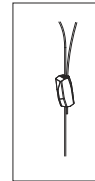

Detail "2" Hanger Connection



Detail "3" Swedged Connection

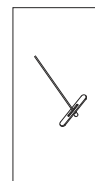

Detail "4" Toggle Connector