



5" UNIVERSAL TC HOUSING

INCANDESCENT LAMPS

TC20 SERIES

Project: _____

Fixture Type: _____

Location: _____

Contact/Phone: _____

PRODUCT DESCRIPTION

TC Housing design for use in non-insulated areas • If installed where insulation is present, the insulation must be pulled back 3" from all sides of the TC housing.

PRODUCT SPECIFICATIONS

Lamp Lamp ratings based on trim selected—see page 2.

Socket Medium base porcelain with nickel-plated copper screw shell
• Drop socket with spring to accommodate certain trim installation.

Trims Trim selection shown on reverse.

Labels UL listed for through-branch wiring, damp locations and IP
• Product thermally protected against improper use of lamps or insulation
• Union made • UL Listed/CSA certified • Trims 210N, 211 and 212N are wet location approved for covered ceiling applications • Trims 215 and 216 are wet location approved for covered ceiling applications,
when used with outdoor rated lamps.

Testing All reports are based on published industry procedures; field performance may differ from laboratory performance.
Specifications subject to change without notice.

INSTALLATION

Real Nail® Bar Hangers Telescoping, Patented (US Patent D552,969) Real Nail 3 and Real Nail 2 systems permits quick placement of housing anywhere within 24" O.C. joists or suspended ceilings • Bars scored in two locations for fast, clean breaking, allowing housing installation in tight applications • Bars captive to mounting frame • Edge-mounted for extra strength • Quick-Loc slot (location identified on the mounting frame) and oversized locking set screw lock fixture in position • May be installed either perpendicular or parallel to junction box.

Real Nail 3 Bar Hanger Integral T-bar notch and clip secures housing in suspended ceiling grid – no accessory clips required • 24" expansion stop allows quick placement of fixture in standard grid spacing
• Captive bugle-headed ring shank nail for quick one-step installation and easy removal with claw hammer for fixture relocation • Bar hanger foot contoured to align to bottom of construction joist • Alternate mounting holes included.

Real Nail 2 Bar Hanger (S options) Small bar hanger foot designed to install directly on strapping construction material • Features Real Nail captive nail system for quick one-step installation • G2405 accessory clips required for suspended ceiling installation.

Junction Box Pre-wired junction box provided with (5) ½" and (1) ¾" knockouts, (4) Non-metallic sheathed cable connectors and ground wire, UL listed/CSA certified for through-branch wiring, maximum 8 No. 12 AWG 90° C branch circuit conductors (4 in, 4 out) • Junction box provided with removable access plates • Knockouts equipped with pryout slots

Mounting Frame 22-gauge die-formed galvanized steel mounting frame • Rough-in section (junction box, mounting frame, housing and bar hangers) fully assembled for ease of installation • Sight lines embossed on mounting frame to allow for easy viewing when aligning fixtures.

Housing .032" aluminum housing • Housing is vertically adjustable to accommodate up to a 1" ceiling thickness.

PRODUCT CODES

Catalog Number		Input Voltage	Lamp Rating
TC20	5" Incandescent New Construction Non-IC Housing	120V	A19/BR30/PAR20/PAR30/PAR30L/R20 (See page 2 for max. trim rating)
TC20 S	5" Incandescent New Construction Non-IC Housing with smaller footprint bar hanger (Real Nail 2)	120V	A19/BR30/PAR20/PAR30/PAR30L/R20 (See page 2 for max. trim rating)

Housing and trim can be ordered together or separate, but will always ship separately.

DIMENSIONS

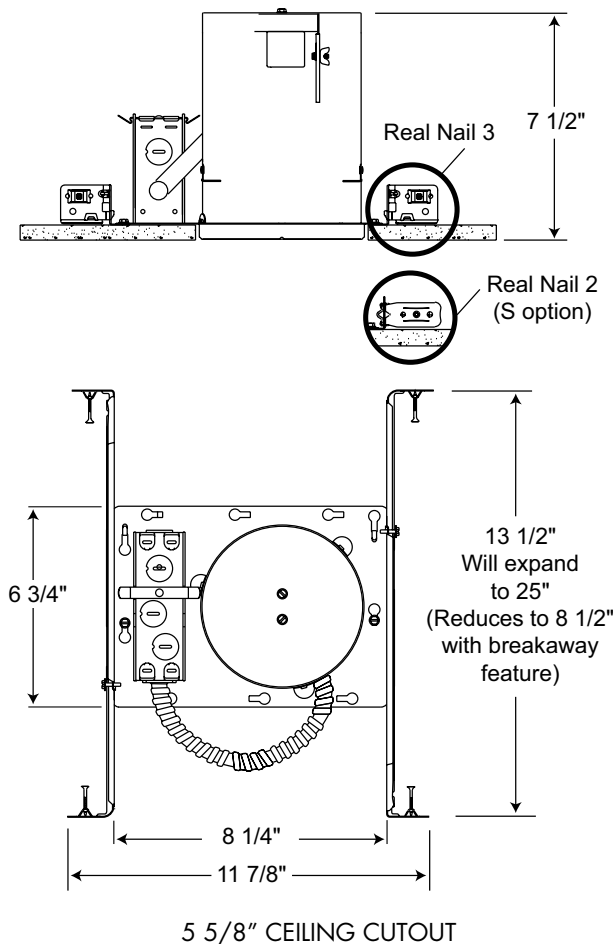

Accessories

Catalog Number	Description
G2405	T-Bar Clips (Set of 4), for S option only















To order, specify catalog number.

5" UNIVERSAL TC HOUSING

INCANDESCENT LAMPS

TC20 SERIES

TRIMS/LAMPS

	Catalog Number	Description	Max. Lamp Rating
** 	203 WWH	White Baffle, White Trim Ring	75W PAR30, 65W BR30
	205 BWH	Black Baffle, White Trim Ring	75W PAR30, 65W BR30
** 	205 WWH	White Baffle, White Trim Ring	
	205 BSC	Black Baffle, Satin Chrome Trim Ring	
	205 BBRZ	Black Baffle, Bronze Trim Ring	
	204 CWH	Clear Alzak® Cone, White Trim Ring	75W PAR30L, 75W PAR30, 65W BR30
	204 GWH	Gold Alzak® Cone, White Trim Ring	
** 	204 BWH	Black Alzak® Cone, White Trim Ring	
	204 HZWH	Haze Cone, White Trim Ring	
	204 WWH	Gloss White Cone, White Trim Ring	
	204 WHZWH	Wheat Haze Cone, White Trim Ring	
	204 WHZBRZ	Wheat Haze Cone, Bronze Trim Ring	
	206 CWH	Clear Alzak® Cone, White Trim Ring	75W PAR30, 65W BR30
** 	206 BWH	Black Cone, White Trim Ring	
	206 HZWH	Haze Cone, White Trim Ring	
	206 WHZWH	Wheat Haze Cone, White Trim Ring	
	206 WHZBRZ	Wheat Haze Cone, Bronze Trim Ring	
	207 CWH	Clear Alzak® Cone, White Trim Ring	50W PAR20/R20
** 	207 BWH	Black Cone, White Trim Ring	
	207 WWH	White Cone, White Trim Ring	
	207 HZWH	Haze Cone, White Trim Ring	
 	215 BWH ◆◆	Black Baffle, White Trim Ring	75W PAR30L, 75W PAR30 w/Socket Extender,
	215 WWH ◆◆	White Baffle, White Trim Ring	60W A19, 85W BR30
	216 CWH ◆◆	Clear Alzak® Cone, White Trim Ring	75W PAR30L, 75W PAR30 w/Socket Extender,
 	216 WWH ◆◆	White Cone, White Trim Ring	85W BR30, 60W A19 (Clear, Gold, Haze and
	216 HZWH ◆◆	Haze Cone, White Trim Ring	Wheat Haze Cones), 40W A19 (White Cone)
	216 WHZWH ◆◆	Wheat Haze Cone, White Trim Ring	
	688 BWH	Black Baffle, White Trim Ring	75W PAR30
	688 WWH	White Baffle, White Trim Ring	
	689 CWH	Clear Alzak® Cone, White Trim Ring	75W PAR30
 	210N WH ◆	Lensed Flat Glass Shower Trim, White	40W A19
 	212N WH ◆	Frosted Lens with Clear Center Trim, White	60W A15, 75W PAR30

Trim Size: 6 1/4" O.D.

Alzak is a registered trademark of Alcoa Corp.

Note: In Canada when insulation is present,
Type IC fixtures must be used.

◆ UL Listed for use in wet location.

◆◆ UL Listed for use in wet location with outdoor rated lamp.

** NOTE: TR5 Trim Ring compatible with 203, 204, 205, 206, 207 trims.

Housing and trim can be ordered together or separate, but will always ship separately.