

Catalog Number
Notes
Type

## FEATURES & SPECIFICATIONS

**INTENDED USE** — The CPANL™ Series LED switchable lumen flat panel features an internal driver and deep drawn backplate. This reliable and rigid flat panel is visually comfortable and can be recessed, direct ceiling mounted, suspended or surface box mounted. Suitable for many applications such as schools, offices, retail, convenience stores, hospitals, healthcare facilities and other commercial spaces. **Certain airborne contaminants can diminish the integrity of acrylic and/or polycarbonate.** [Click here for Acrylic-Polycarbonate Compatibility table for suitable uses.](#)

**CONSTRUCTION** — This edge-lit platform was built to last with an aluminum frame for strength and durability, the seamless frame prevents light leak in the corners. The satin white lens provides excellent shielding and fully luminous appearance. CPANL's low-profile design provides increased installation flexibility especially in restricted plenum spaces. The back plate includes integral T-bar clips for installation into 9/16" or 15/16" T-grid ceilings. Fixture may be direct ceiling mounted with the DCMK bracket on a hard-ceiling see accessories section for more information. Fixture may be mounted and wired in continuous rows.

**ELECTRICAL** — Long-life LEDs, coupled with a high-efficiency driver, provide superior illumination for extended service life. 70% LED lumen maintenance at 60,000 hours (L70/60,000). 0-10V dimming driver, dims to 10% and contains non-isolated dimming leads. Switch set to max high lumen output at the factory. For optimal 0-10V dimming performance it is recommended that the luminaire remains at factory default high lumen setting.

**LISTINGS** — CSA certified to meet US and Canadian standards. Intended for indoor use only. Product is not to be stored in non-climate controlled spaces. Damp location listed. IC rated. IPSX Rated.

DesignLights Consortium® (DLC) qualified product. Not all versions of this product may be DLC qualified. Please check the DLC Qualified Products List at [www.designlights.org/QPL](http://www.designlights.org/QPL) to confirm which versions are qualified.

Rated for NSF/ANSI Standard 2 - Light Fixture for Splash Zone and Non Food Zone.

**WARRANTY** — 5-year limited warranty. This is the only warranty provided and no other statements in this specification sheet create any warranty of any kind. All other express and implied warranties are disclaimed. Complete warranty terms located at:

[www.acuitybrands.com/support/warranty/terms-and-conditions](http://www.acuitybrands.com/support/warranty/terms-and-conditions)

**Note:** Actual performance may differ as a result of end-user environment and application. All values are design or typical values, measured under laboratory conditions at 25 °C. Specifications subject to change without notice.

# CPANL LED

Lumen Switchable Panel

1' x 4', 2' x 2' and 2' x 4'

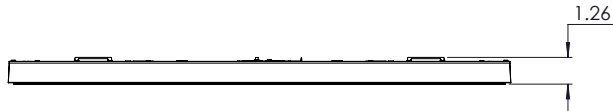

### ORDERING INFORMATION

Catalog Number	UPC	Description	Nominal Lumens	Color Temperature	CRI	Voltage	Nominal Wattage	Pallet QTY
CPANL 1X4 ALO1 SWW7 M4	00194995124930	1x4 Fully Switchable Flat Panel	2400/3300/ <b>4400</b>	35/ <b>40</b> /50K	>80	MVOLT (120-277)	22/31/ <b>41</b>	56
CPANL 2X2 ALO1 SWW7 M4	00194995124923	2x2 Fully Switchable Flat Panel	2400/3300/ <b>4400</b>	35/ <b>40</b> /50K	>80	MVOLT (120-277)	22/31/ <b>41</b>	56
CPANL 2X4 ALO6 SWW7 M2	00194995124916	2x4 Fully Switchable Flat Panel	4000/5000/ <b>6000</b>	35/ <b>40</b> /50K	>80	MVOLT (120-277)	36/45/ <b>55</b>	28

View Contractor Select versions, [Click here](#) or visit [www.acuitybrands.com](http://www.acuitybrands.com) and search for CPANL

\* Bolded lumen package designates default switch setting.

## ACCESSORIES

Accessories: Order as separate catalog number.	
ILBLP CP10 HE SD A	IOTA emergency constant power battery pack field installation kit (Certified in CA Title 20 MAEDBS) <sup>1</sup>
ELA PSDMT	External mounting tray to secure emergency battery to building structure, not required, battery can be mounted to fixture
DCMK 14	Direct Ceiling Mount Kit for CPANL 1x4
DCMK 224	Direct Ceiling Mount Kit for CPANL 2x4 and 2x2
1X4SMKSH	Surface Mount Kit 1'x4', Shallow Depth
2X2SMKSH	Surface Mount Kit 2'x2', Shallow Depth
2X4SMKSH	Surface Mount Kit 2'x4', Shallow Depth
DGA14	Drywall grid adapter for 1x4 recessed fixture.
DGA22	Drywall grid adapter for 2x2 recessed fixture.
DGA24	Drywall grid adapter for 2x4 recessed fixture.
PAC 2DNF 36	Panel Air Craft Kit, 2 cables with Y splitter, No Power Feed, 36 inches <sup>2</sup>
PAC 2DF 36	Panel Air Craft Kit, 2 cables with Y splitter, with Power Feed, 36 inches <sup>2</sup>
PAC 2DNF 72	Panel Air Craft Kit, 2 cables with Y splitter, No Power Feed, 72 inches <sup>2</sup>
PAC 2DF 72	Panel Air Craft Kit, 2 cables with Y splitter, with Power Feed, 72 inches <sup>2</sup>
PAC 4DNF 36	Panel Air Craft Kit, 4 cables, No Power Feed, 36 inches <sup>2</sup>
PAC 4DF 36	Panel Air Craft Kit, 4 cables, with Power Feed, 36 inches <sup>2</sup>
PAC 4DNF 72	Panel Air Craft Kit, 4 cables, No Power Feed, 72 inches <sup>2</sup>
PAC 4DF 72	Panel Air Craft Kit, 4 cables, with Power Feed, 72 inches <sup>2</sup>

### Emergency Battery Delivered Lumens

Use the formula below to determine the delivered lumens in emergency mode

$$\text{Delivered Lumens} = 1.25 \times P \times \text{LPW}$$

**P** = Output power of emergency driver (10W for PS1055)

**LPW** = Lumen per watt rating of the luminaire.

### NOTES

- See Power Sentry [PS1055CP battery spec sheet here](#). Test switch must be remote mounted or installed in an adjacent ceiling tile.
- See Suspension Kits section below for additional detail.

Switchable Table						
Size	Nomenclature	Lumen Setting	CCT	Lumen	Wattage	Efficacy
1x4	CPANL 1X4 ALO1 SWW7 M4	Low Lumen	3500K	2645	21.6	122
			4000K	2712	20.9	130
			5000K	2637	21.4	123
		Medium Lumen	3500K	3599	30.7	117
			4000K	3754	29.4	128
			5000K	3595	30.4	118
		High Lumen	3500K	4597	40.5	114
			<b>4000K</b>	<b>4881</b>	<b>38.7</b>	<b>126</b>
			5000K	4596	40.1	115
2x2	CPANL 2X2 ALO1 SWW7 M4	Low Lumen	3500K	2617	21.6	121
			4000K	2750	20.9	132
			5000K	2766	21.5	129
		Medium Lumen	3500K	3778	30.6	123
			4000K	3930	29.4	134
			5000K	3755	30.5	123
		High Lumen	3500K	4741	40.5	117
			<b>4000K</b>	<b>5031</b>	<b>38.8</b>	<b>130</b>
			5000K	4717	40.4	117
2x4	CPANL 2X4 ALO6 SWW7 M2	Low Lumen	3500K	4363	35.7	122
			4000K	4450	34.4	129
			5000K	4358	35.4	123
		Medium Lumen	3500K	5354	45.1	119
			4000K	5509	43.3	127
			5000K	5351	44.8	119
		High Lumen	3500K	6343	55.1	115
			<b>4000K</b>	<b>6579</b>	<b>52.7</b>	<b>125</b>
			5000K	6353	54.7	116

\* Bolded lumen, color temperature and wattage designates default switch setting.

### Emergency Battery Pack Options - Field Installable



Battery Model Number	Wattage	Runtime (Minutes)	Lumen Output* @ 120 Lumens/Watt	Other
<a href="#">ILB CP07 2H A</a>	7W	120	840	Storm Shelter/ 2-hour Runtime
<a href="#">ILB CP10 A</a>	10W	90	1200	
<a href="#">ILB CP10 HE AELR A</a>	10W	90	1200	Title 20; Enabled with Self Testing, Automated Reporting (STAR)
<a href="#">ILBLP CP10 HE SD A</a>	10W	90	1200	Title 20, Self Diagnostic
<a href="#">ILBLP CP15 HE SD A</a>	15W	90	1800	Title 20, Self Diagnostic
<a href="#">ILB CP20 HE A</a>	20W	90	2400	Title 20
<a href="#">ILB CP20 HE SD A</a>	20W	90	2400	Title 20, Self Diagnostic

All the above are UL 924 Listed products that are certified for field install external/remote to the fixture.  
 \*Minimum delivered lumen output to assist in product selection for increased fixture mounting height.  
 Delivered emergency illumination of CP10 models outperforms legacy 1400 lumen fluorescent emergency ballasts.  
 Please contact us at [techsupport@iotaengineering.com](mailto:techsupport@iotaengineering.com) for any Emergency Battery related questions.

### Enabled with STAR

**Emergency Lighting with Self-Testing Automated Reporting (STAR)**, enables self-testing and automated reporting to aid in life safety code compliance. Build your solution and choose your preferred deployment from Mobile STAR, where test data is logged in each individual unit and broadcast to the **CLAIRity™+ app**, or Connected STAR, where test data is logged in the STAR Gateway by IOTA® and emailed directly. **Leave the ladders, disruptions and written records behind with emergency lighting solutions with STAR!**

**Life Safety Code NFPA 101 testing and reporting requirements for emergency lighting include:**

-  Testing for 30 seconds every 30 days
-  Testing for 90 minutes once a year
-  Record keeping and to report to the authority having local jurisdiction

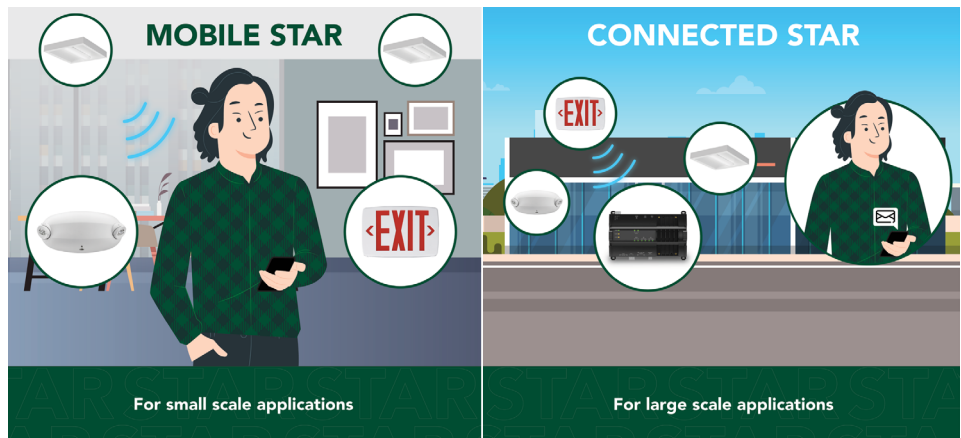

### Suspension Kits

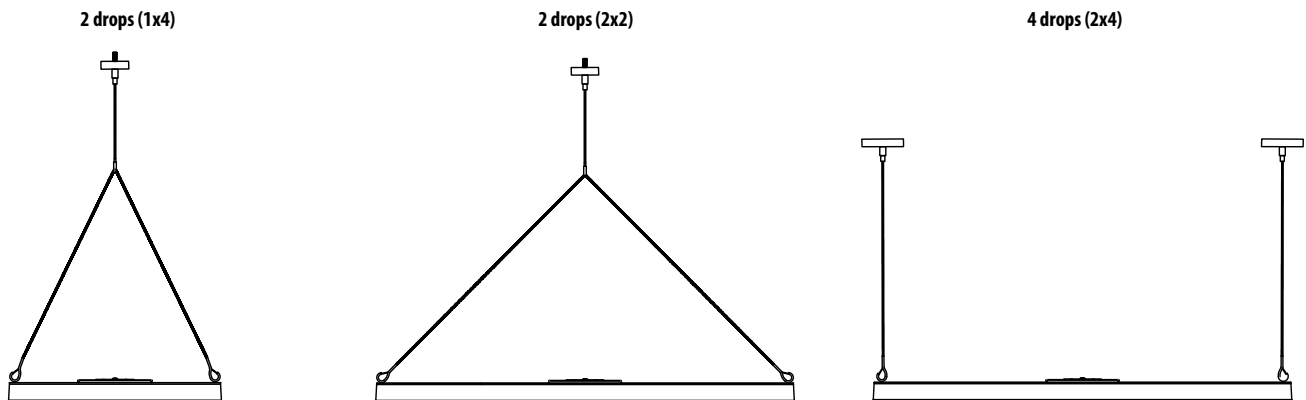

# CPANL LED Flat Panel

CPANL compatible with Sensor Switch™  
WSX-D and SPOD wall switches.



WSX-D



SPOD

## PHOTOMETRICS

See [www.lithonia.com](http://www.lithonia.com) for photometry reports.

## DIMENSIONS

Length: 11.9(30.2)  
Width: 47.7 (121.12)  
Depth: 1.1 (2.7)  
Weight:  
Unit Carton: 9.3lbs  
Unit Carton: 10.3lbs  
Master Carton: 43.2lbs

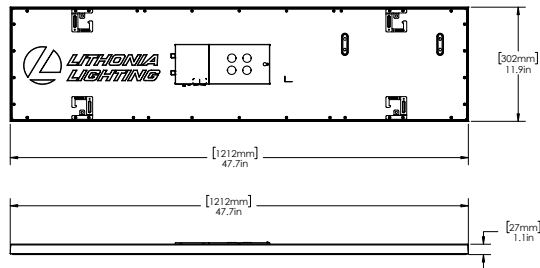

Length: 23.8 (60.4)  
Width: 23.8 (60.4)  
Depth: 1.1 (2.7)  
Weight:  
Unit: 9.0lbs  
Unit Carton: 10.0lbs  
Master Carton: 41.9lbs

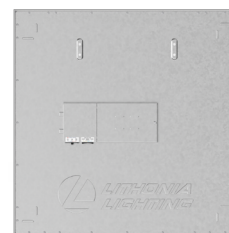
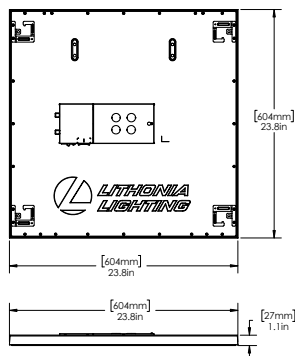

Length: 47.8 (121.4)  
Width: 23.8 (60.4)  
Depth: 1.1 (2.7)  
Weight:  
Unit: 17.8lbs  
Unit Carton: 19.7lbs  
Master Carton: 43.3lbs

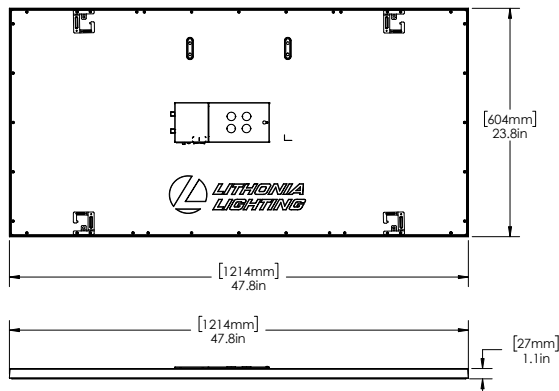

**DCMK - DIRECT CEILING MOUNT KITS** (Sold as a separate accessory, see accessories section on page 1)

**DCMK 14**

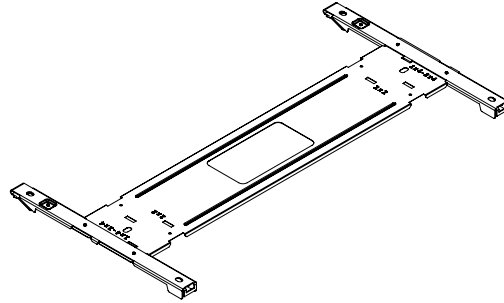
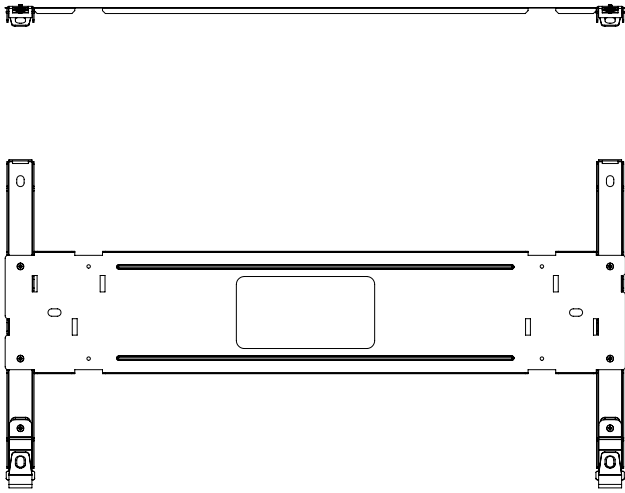

**Specification DCMK 14**

Length	11-3/8 (29)
Width	21-1/2 (54.4)
Height	11/16 (1.8)
Bracket Weight	1.0 lbs

**DCMK 224**

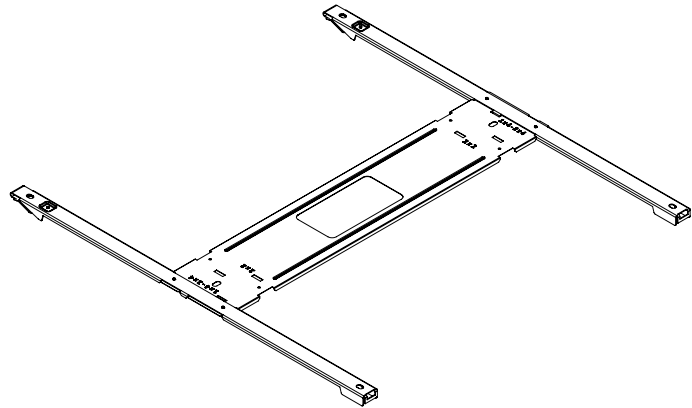
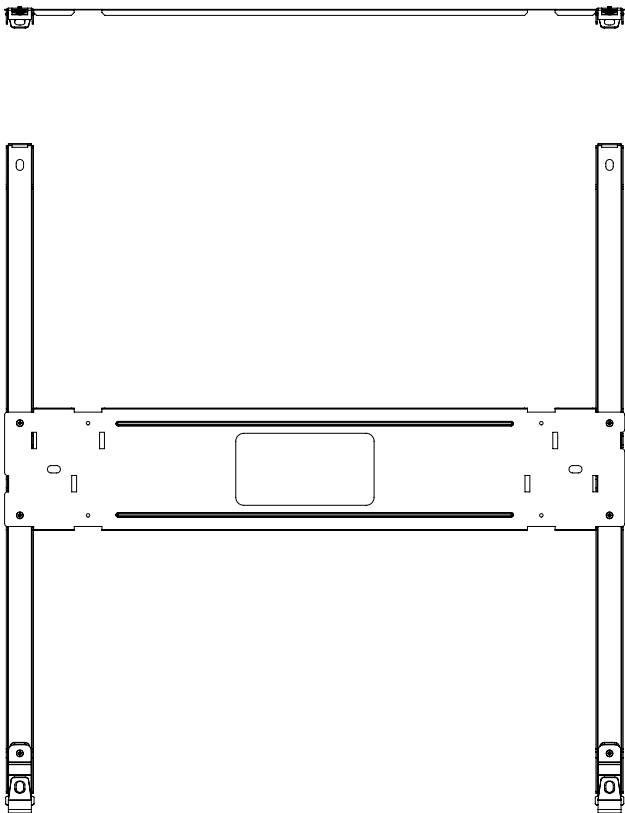

**Specification DCMK 224**

Length	23-14 (59)
Width	21-1/2 (54.4)
Height	11/16 (1.8)
Bracket Weight	1.4 lbs