

OVERVIEW

The nCM xx RJB family of nLight ceiling/surface mount occupancy sensors provide a range of networked sensor solutions for applications with finished ceilings (e.g. ceiling tiles, sheetrock, plaster). nCM xx RJB family sensors utilize 100% digital Passive Infrared (PIR) detection and are available with several lens options, providing flexibility for multiple mounting height and coverage pattern requirements. Dual technology occupancy detection can also be added as an option for applications where occupants are stationary for long periods of time. nCM xx RJB family sensors are also available with an optional auxiliary low voltage relay for simple integration with a BMS system or other building system.

nCM xx RJB family sensors are powered via the nLight network bus and typically communicate with one or more nLight enabled luminaires (e.g. Lithonia VTLED Series) or nLight relay/dimming packs to enable control of fixtures individually or in groups. These configurations work standalone and do not require a connection to a larger nLight network.

FEATURES

- 100% digital PIR detection
- Optional dimming photocell (ADCX option)
- Optional auxiliary low voltage relay (AR option) for dry contact output – relay only tracks occupancy by default, ignoring switch and photocell commands
- LED status indicator
- Adjustable settings (e.g. occupancy time delays, photocell set-points) via push-button or SensorView software application
- Broadcasts occupancy and photocell information over a local nLight channel
- Remotely upgradeable firmware

Buy American Act

Product with the BAA option is assembled in the USA and meets the Buy America(n) government procurement requirements under FAR, DFARS and DOT regulations.

Build America Buy America

Product with the BAA option also qualifies as produced in the United States under the definitions of the Build America, Buy America Act.

Please refer to www.acuitybrands.com/buy-american for additional information.

Warranty

Five-year limited warranty. This is the only warranty provided and no other statements in this specification sheet create any warranty of any kind. All other express and implied warranties are disclaimed. Complete warranty terms located at: www.acuitybrands.com/support/warranty/terms-and-conditions

Note: Actual performance may differ as a result of end-user environment and application.

Specifications subject to change without notice.



nCM xx RJB
nCM PDT xx RJB



nCM 9 RJB
nCM PDT 9 RJB



nCM 10 RJB
nCM PDT 10 RJB



nCM 6 RJB



This item is an A+ capable component, which has been designed and tested to provide out-of-the-box luminaire compatibility with simple commissioning, when included as part of an A+ Certified™ Solution.

To learn more about A+, visit www.acuitybrands.com/aplus.



Items marked by a shaded background qualify for the Design Select program and ship in 15 days or less. To learn more about Design Select, visit www.acuitybrands.com/designselect.

*See ordering tree for details



ORDERING INFORMATION

nCM xx RJB		Example: nCM PDT 9 ADCX RJB		
Series / Detection	Coverage Type	Options (See Below)	RJ45 Port Location	Buy America(n) ²
nCM PIR Detection	9 Small Motion 360°		RJB Rear RJ45 (CAT5e patch cable & RJ45 splitter included)	blank Standard
nCM PDT Dual Tech (PIR/ Microphonics)	10 Large Motion 360°			BAA Buy America(n) Act and/or Build America Buy America Qualified
	6 High Mount 360° (not available with PDT version)			

nCM xx RJB Options				
Photocell	Auxiliary Relay	Preset Type ¹	Time Delay	Temp/ Humidity
[blank] Standard (No photocell)	[blank] None	[blank] Single Time Delay	[blank] Standard	[blank] Standard
ADCX Automatic Dimming Control (of remote dimming output)	AR Low Voltage Aux. Relay	2P Dual Time Delay	15M 15 Minutes 20M 20 Minutes 30M 30 Minutes	LT Low Temp / High Humidity

NOTES:

1. Not available with AR or ADCX options.
2. Not available with AR, 2P, Time Delay, or LT options

COVERAGE PATTERNS*

SMALL MOTION 360° (Model # nCM 9/nCM PDT 9¹)



- Best choice for small motion (e.g. hand movements) detection
- 360° conical shaped pattern
- Provides 12 ft (3.66 m) radial coverage (~500 ft²) when mounted to standard 9 ft (2.74 m) ceiling
- 8 to 15 ft (2.44 to 4.57 m) mounting heights provide 10 to 20 ft (3.05 to 6.10 m) radial coverage

SIDE VIEW

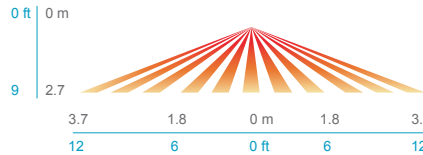

TOP VIEW

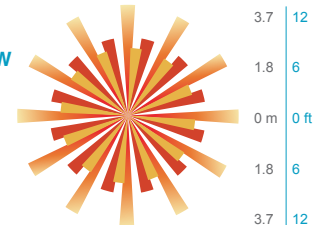

¹ Sensors with Microphonics™ provides overlapping detection of human activity over the complete PIR coverage area. Advanced filtering is also utilized to prevent non-occupant noises from keeping the lights on.

LARGE MOTION 360° (Model # nCM 10/nCM PDT 10¹)



- Best choice for large motion detection (e.g. walking)
- 360° conical shaped pattern
- Provides ~24 ft (7.32 m) radial coverage (~2000 ft²) when mounted at 9 ft (2.74 m)
- 7 to 15 ft (2.13 to 4.57 m) mounting heights provide 16 to 36 ft (4.88 to 10.97 m) radial coverage
- Detection range improves when walking across beams compared to into beams

SIDE VIEW

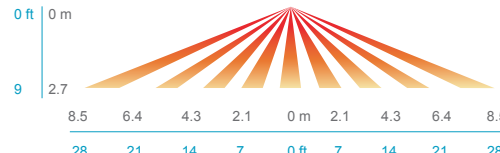

TOP VIEW

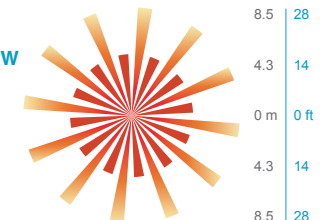

¹ Sensors with Microphonics™ provides overlapping detection of human activity over the complete PIR coverage area. Advanced filtering is also utilized to prevent non-occupant noises from keeping the lights on.

HIGH MOUNT 360° (Model # nCM 6)



- Best choice for 15 to 45 ft (4.57 to 13.72 m) mounting heights
- 15 to 20 ft (4.57 to 6.10 m) radial coverage overlaps area lit by a typical high bay fixture
- Excellent detection of large motion (e.g. walking) up to 35 ft (10.76 m)
- Excellent detection of extra large motion (e.g. forklifts) up to a 45 ft (13.72 m)

LOW VIEW

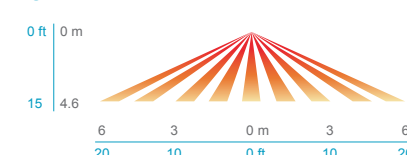

HIGH VIEW

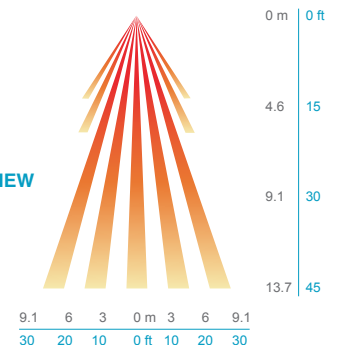

* Coverage pattern shown is derived from NEMA WD7 testing

TYPICAL APPLICATIONS

Wiring to an nLight Relay Pack

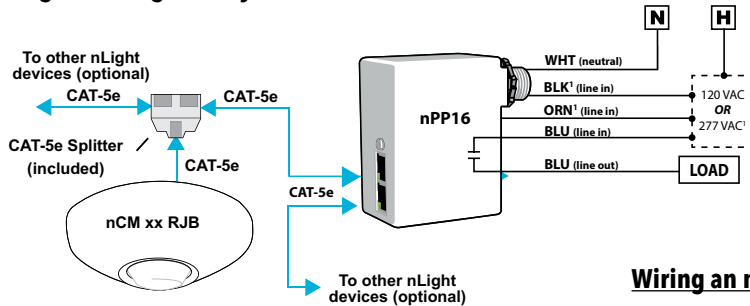

Wiring an nCM xx ADCX RJB to an nLight Dimming Pack

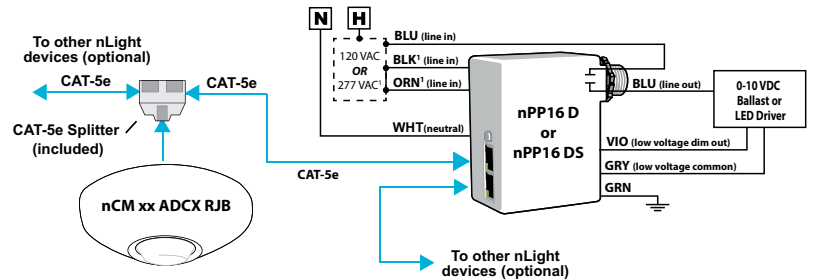

Wiring to an nLight Enabled Luminaire

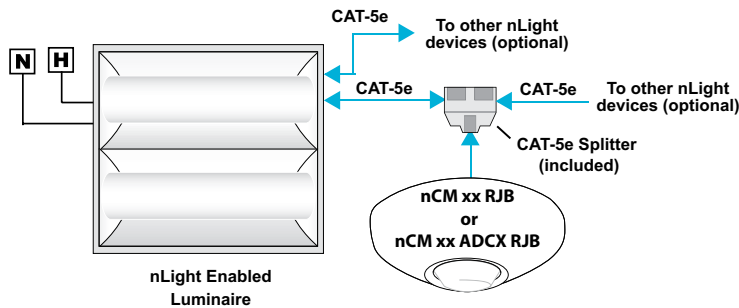

TYPICAL APPLICATIONS

The following instructions are for mounting sensor directly to a ceiling tile or sheetrock surface.¹ Sensor's mounting holes also align with standard round fixture or single gang handy box (screws not provided).

1. Using template included with unit, mark spots on ceiling tile/sheetrock for cable hole and mounting anchors/screws
2. Drill 1/2" hole through ceiling surface at location indicated on template
3. Insert provided anchors into ceiling surface at locations indicated on template
4. Remove provided RJ-45 splitter from sensor's attached CAT5e cable and then thread cable (and low voltage wires if **-AR** option included) through hole from underside
5. Mount sensor to anchors using two screws provided
6. Attach provided RJ45 splitter device (model **CAT5 Y**) above ceiling to cable from sensor (see diagram on right)
7. Interconnect CAT-5e cables to/from rest of nLight zone to RJ45 splitter²
8. Once power is received via CAT-5e connection, all devices in zone will automatically begin functioning together according to each device's defaults
9. Install decorative sensor lid by rotating clockwise
10. Refer to included instruction card for default settings and directions on push-button programming.

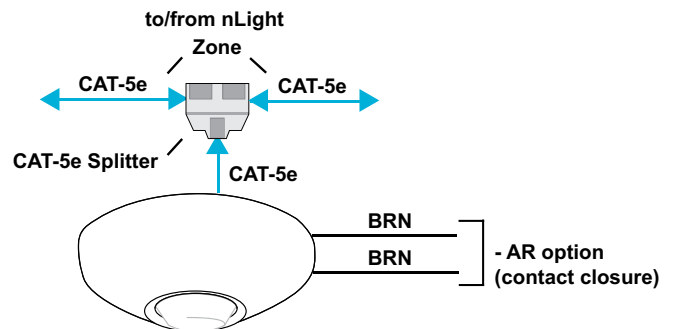

Note:

1. Recommended mounting 4' or more away from HVAC vents.
2. T568B pin/pair assignment is recommended for all CAT-5e cables. Sensor power is provided via a CAT-5e connection to an nLight power pack/supply, nLight enabled digital luminaire, or nLight Bridge.

SPECIFICATIONS

Electrical

Input Ratings	15-24VDC, 3mA, Class 2 (nLight network power)
Output Ratings	24 VAC/VDC, 1A - Resistive (AR option)
Relay Type	Latching (AR option)
Standards/ Ratings	Energy Management Equipment, UL916 (E167435)

Mechanical

Dimensions	4.55"W x 1.55"D (116mm x 40mm)
Mounting	Single-Gang or Octagonal Box, Surface Mount
Color	White
Finish	Matte
Connection Type	RJ-45 nLight Network Ports (2 ports via included RJ-45 splitter) Low-Voltage Leads (AR option)

Environmental

Warrantied Operating Temperature	Standard: 14°F to 185°F (-10°C to 85°C) PDT option: 14°F to 140°F (-10°C to 60°C) LT option: -4°F to 185°F (-20°C to 85°C) PDT LT options: -4°F to 140°F (-20°C to 60°C)
Relative Humidity	Up to 90%, Non-Condensing
Standards/ Ratings	RoHS

General

Standards/ Ratings	System Component to aid in compliance with Title 24, ASHRAE 90.1, IECC
---------------------------	--