

## OVERVIEW

The nPODM xS Series WallPods are single gang nLight-enabled devices that provide one, two, and four scene control. These units provide a convenient method of selecting a custom lighting control scene for the room in which it is installed, or requesting a global profile scene be run across several remote zones. By default, however, the buttons of an nPODM xS are configured as on/off toggle switches. Scenes are programmed to these units utilizing available SensorView software.

The nPODM xS has soft-click push-buttons with a green LED indicator for each button. These button are field replaceable and can be custom engraved. Two RJ-45 connectors allow the nPODM xS to be daisy-chain wired with CAT-5e cabling to other nLight network devices.

The nPODM xSB offers individual on/off buttons for each scene. Pressing the "on" button will reset the expiration time of a scene back to the original programmed time.\*

\*In order to utilize a blink warning, system gateway and additional programming is required. nPODM xSB WallPods are not recommended for use with "preset" style scenes.

## FEATURES

- Communicates w/ nLight network
- Remotely configurable/upgradable
- Runs locally stored scenes or global scenes (stored on gateway)
- Capable of Programming 4 Different Scene Types
  - Local "Profile" Scene – Modifies the operational configuration of up to 80 devices in the local zone. Stopping scene will revert devices to default settings.
  - Local "Preset" Scene – Modifies on/off/dim levels for up to 16 local switch groups. Exit scene through additional "preset" scene or WallPod control.
  - Global "Profile" Scene – Modifies the operational configuration of any devices on the system. Stopping scene will revert devices to default settings. Scene is stored on the system Gateway, model nGWY2 KIT.
  - Global "Preset" Scene – Modifies on/off/dim levels for up to 128 global switch groups. Exit scene through additional "preset" scene or WallPod control.
- Expiration timer programmable to each scene
- Programmable to initiate occ. sensor time delay sweep
- "Dynamic" options for custom button names when pairing with Acuity Brands nTUNE fixtures

## Warranty

Five-year limited warranty. Complete warranty terms located at: [www.acuitybrands.com/CustomerResources/Terms\\_and\\_conditions.aspx](http://www.acuitybrands.com/CustomerResources/Terms_and_conditions.aspx)

**Note:** Actual performance may differ as a result of end-user environment and application. Specifications subject to change without notice.



nPODM 1SB  
nPODM 2S(B)  
nPODM 4S(B)



## ORDERING INFORMATION

nPODM		Example: nPODM 1SB WH							
Series	# of Scenes	Dimming Control		Dynamic		Color		Temp/Humidity	
nPODM	1SB 1 Scene control (2 buttons)	[blank]	Standard	[blank]	Standard	WH	White	[blank]	Standard
	2S 2 Scene control (2 buttons)	DX <sup>1</sup>	On/off + raise/ lower control	EDUTW <sup>2</sup>	Tunable White	IV	Ivory	LT	Low temp
	2SB 2 Scene control (4 buttons)			GRSC <sup>3</sup>	Grayscale	GY	Gray		
	4S 4 Scene control (4 buttons)			COLOR <sup>3</sup>	Color control	AL	Almond		
	4SB 4 Scene control (8 buttons)					BK	Black		
						RD	Red		

Notes

1. Available with 2S and 4S versions
2. Available with 4S and 4S DX versions
3. Available with 4S DX version only

## OVERVIEW

Below is an outline of example scene configurations for the nPODM 4S. When no local scene is selected, the user configurable device default settings are active.

### DEFAULT SETTINGS (example)

All lights on, dimming photocell enabled

Sensors at 10 minute time delay & in AUTO ON/AUTO OFF mode

#### 1 MOVIE MODE

Button in Local Scene mode

Front rows off, middle rows 75% dim, rear rows 50% dim  
Sensor at 20 minute time delay  
Sensor LEDs off  
Photocell Disabled

#### 2 PRESENTER MODE

Button in Local Scene mode

Podium lights on  
All other rows 60% dim  
Photocell Disabled

#### 3 ACCENT LIGHTS CONTROL

Button in WallPod

Press to toggle on/off

#### 4 PARKING LOT

Button in Remote Scene mode

Runs profile stored on Gateway to turn on parking lot lights

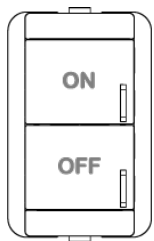

nPODM 1SB

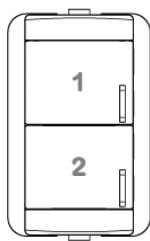

nPODM 2S

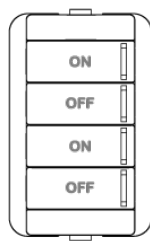

nPODM 2SB

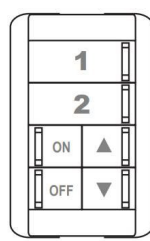

nPODM 2S DX

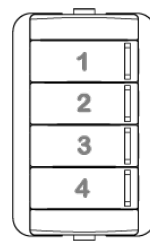

nPODM 4S

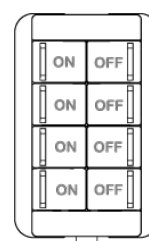

nPODM 4SB

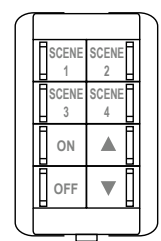

nPODM 4S DX

Dynamic wallpods below are paired with Acuity Brands nTUNE fixtures for out-of-box operation.  
Reference fixture cut sheets for additional details.

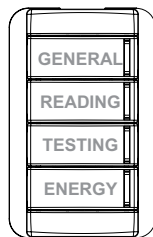

nPODM 4S EDUTW

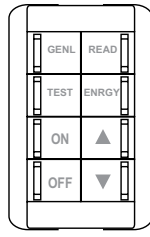

nPODM 4S DX  
EDUTW

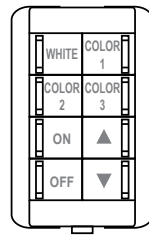

nPODM 4S DX COLOR

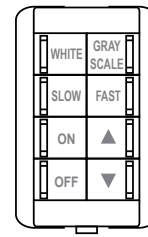

nPODM 4S DX GRSC

Custom engraved lettering for WH, IV, AL, and GY units can be specified and ordered at:

<http://www.acuitybrands.com/-/media/Files/Acuity/Products/Controls/nLight/NGRAVE%20110%20pdf.pdf?la=en>

## INSTALLATION

- Mount WallPod using holes that align with standard single gang switch box or low voltage ring
- Access RJ-45 ports by sliding plastic guard up
- Insert CAT-5e cable(s), T568B wiring convention recommended
- Slide guard back onto metal strap
- Interconnect unit with other nLight devices in lighting zone using CAT-5e cables
- Once power is received via CAT-5e connection, all devices in zone will automatically begin functioning together according to respective device's defaults

**Attention! Only use non-booted CAT5e cables.**

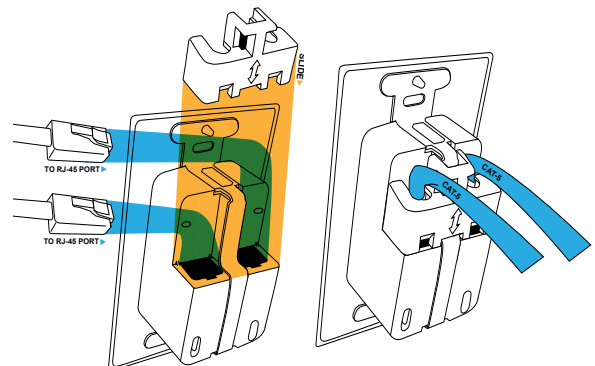

## SPECIFICATIONS

---

<b>Electrical</b>	<b>Input Ratings</b>	15-24VDC, 5mA, Class 2 (nLight network power)
<b>Mechanical</b>	<b>Dimensions</b>	2.74"H x 1.68"W x 1.63"D (70mm x 43mm x 41mm) - does not include ground strap
	<b>Mounting</b>	Single-Gang Box or Low Voltage Ring
	<b>Connection Type</b>	RJ-45 nLight Network Ports (2)
<b>Environmental</b>	<b>Warrantied Operating Temperature</b>	32°F to 140°F (0°C to 60°C)
	<b>Relative Humidity</b>	Up to 90%, Non-Condensing
	<b>Standards/ Ratings</b>	Energy Management Equipment, UL916 (E167435) RoHS
	<b>Security</b>	Complies with California Civil Code Title 1.81.26, Security of Connected Devices, approved under Senate Bill No. 327 (2018)