

FLOODLIGHTING

Brackets and Mounting Hardware
for use with Predator, Prismbeam II, or Vector Luminaires

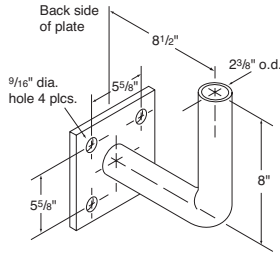

BKT-1-PP
wall bracket
2" slip fitter

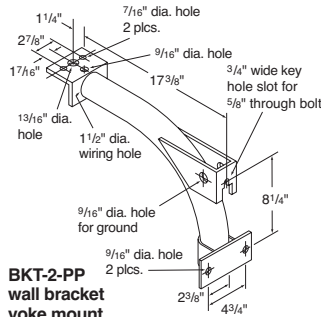

BKT-2-PP
wall bracket
yoke mount

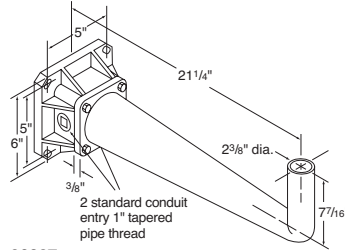

06387
wall bracket
2" slip fitter
cast aluminum
paint finish

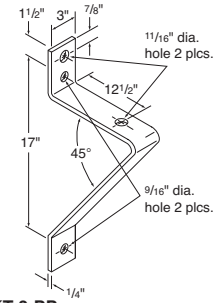

BKT-3-PP
wall or wood pole bracket
yoke mount

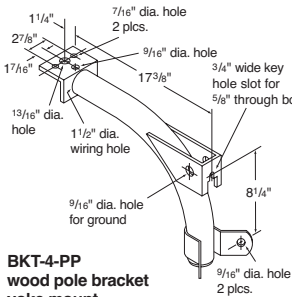

BKT-4-PP
wood pole bracket
yoke mount

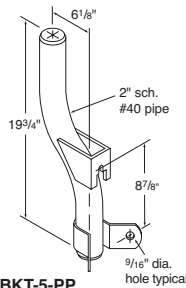

BKT-5-PP
wood pole bracket
2" slip fitter

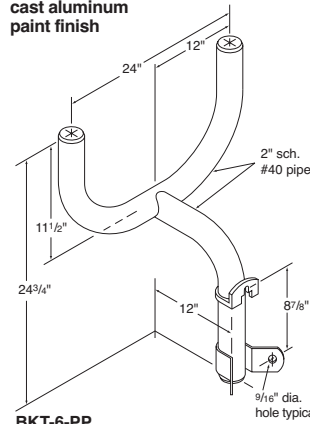

BKT-6-PP
wood pole bracket
2" slip fitter

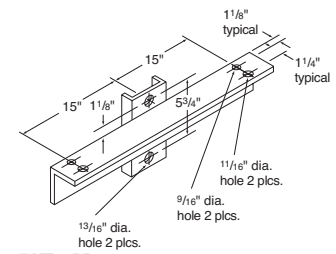

BKT-7-PP
2 light cross-arm

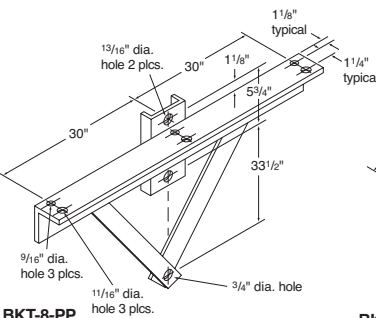

BKT-8-PP
3 light cross-arm
08647 required for
middle fixture

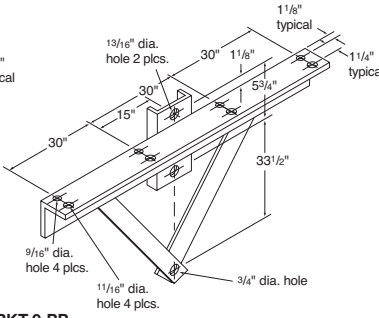

BKT-9-PP
4 light cross-arm

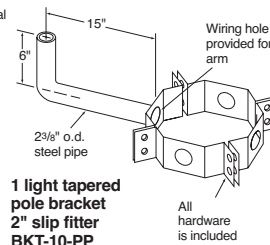

1 light tapered pole bracket
2" slip fitter
BKT-10-PP
7"-10" pole diameter
BKT-11-PP
10"-13" pole diameter

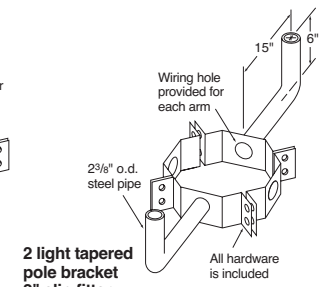

2 light tapered pole bracket
2" slip fitter
BKT-12-PP
7"-10" pole diameter
BKT-13-PP
10"-13" pole diameter

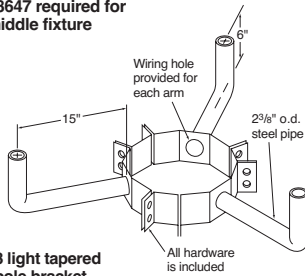

3 light tapered pole bracket
2" slip fitter
BKT-14-PP
7"-10" pole diameter
BKT-15-PP
10"-13" pole diameter

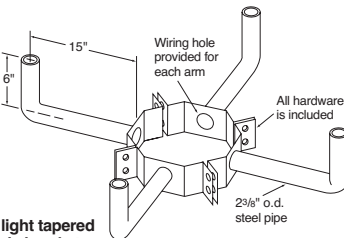

4 light tapered pole bracket
2" slip fitter
BKT-16-PP
7"-10" pole diameter
BKT-17-PP
10"-13" pole diameter

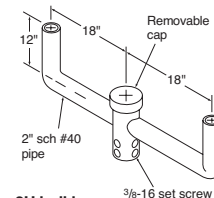

2U bull horn
2" slip fitter
BKT-18-PP
2 3/8" tenon
BKT-19-PP
4" tenon

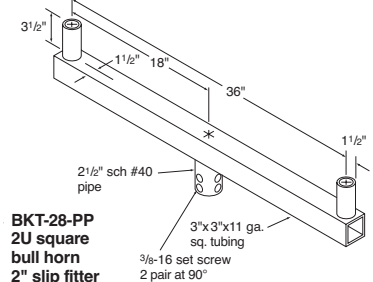

BKT-28-PP
2U square bull horn
2" slip fitter
2 3/8" tenon

Catalog Number Reference Guide

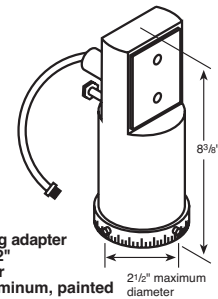
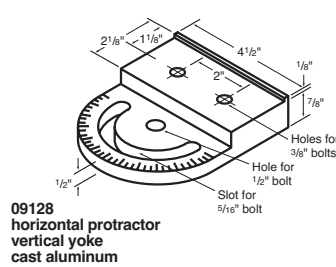
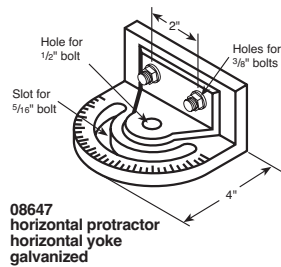
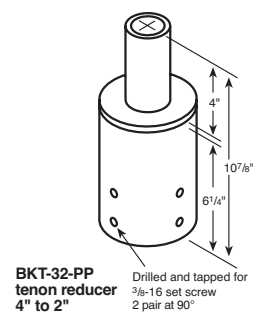
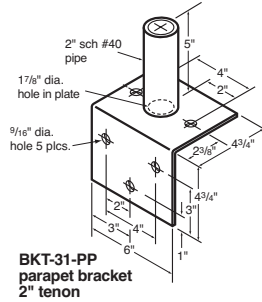
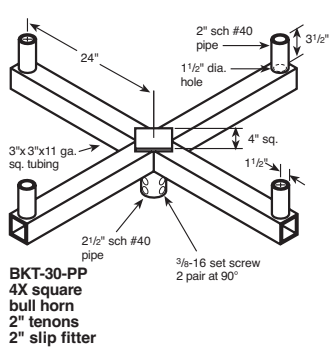

Catalog Number	Description	Net Wt kg (lbs)
BKT-1-XX ¹	Wall bracket, 2" slip fitter, painted	4.5 (10)
BKT-1-HG	Wall bracket, 2" slip fitter, galvanized	4.5 (10)
BKT-1-PP	Wall bracket, 2" slip fitter, prime painted	4.5 (10)
BKT-2-XX ¹	Wall bracket, yoke mount, painted	5 (11)
BKT-2-HG	Wall bracket, yoke mount, galvanized	5 (11)
BKT-2-PP	Wall bracket, yoke mount, prime painted	5 (11)
06387-XX ¹	Wall bracket, 2" slip fitter, cast aluminum	3.2 (7)
BKT-3-XX ¹	Wall or wood pole bracket, yoke mount, painted	4.1 (9)
BKT-3-HG	Wall or wood pole bracket, yoke mount, galvanized	4.1 (9)
BKT-3-PP	Wall or wood pole bracket, yoke mount, prime painted	4.1 (9)
BKT-4-XX ¹	Wood pole bracket, yoke mount, painted	5 (11)
BKT-4-HG	Wood pole bracket, yoke mount, galvanized	5 (11)
BKT-4-PP	Wood pole bracket, yoke mount, prime painted	5 (11)
BKT-5-XX ¹	Wood pole bracket, 1 light, 2" slip fitter, painted	6.4 (14)
BKT-5-HG	Wood pole bracket, 1 light, 2" slip fitter, galvanized	6.4 (14)
BKT-5-PP	Wood pole bracket, 1 light, 2" slip fitter, prime painted	6.4 (14)
BKT-6-XX ¹	Wood pole bracket, 2 light, 2" slip fitter, painted	8.6 (19)
BKT-6-HG	Wood pole bracket, 2 light, 2" slip fitter, galvanized	8.6 (19)
BKT-6-PP	Wood pole bracket, 2 light, 2" slip fitter, prime painted	8.6 (19)
BKT-7-XX ¹	Cross arm, 2 light, painted	9.1 (20)
BKT-7-HG	Cross arm, 2 light, galvanized	9.1 (20)
BKT-7-PP	Cross arm, 2 light, prime painted	9.1 (20)
BKT-8-XX ¹	Cross arm, 3 light, painted	23.1 (51)
BKT-8-HG	Cross arm, 3 light, galvanized	23.1 (51)
BKT-8-PP	Cross arm, 3 light, prime painted	23.1 (51)
BKT-9-XX ¹	Cross arm, 4 light, painted	29.5 (65)
BKT-9-HG	Cross arm, 4 light, galvanized	29.5 (65)
BKT-9-PP	Cross arm, 4 light, prime painted	29.5 (65)

¹ Substitute "GR" or "BZ" for "XX" in catalog number to indicate gray or bronze respectively

Catalog Number	Description	Net Wt kg (lbs)
BKT-10-XX ¹	Tapered pole bracket, 7–10" diameter pole, 1 light, 2" tenon, painted	9.1 (20)
BKT-10-HG	Tapered pole bracket, 7–10" diameter pole, 1 light, 2" tenon, galvanized	9.1 (20)
BKT-10-PP	Tapered pole bracket, 7–10" diameter pole, 1 light, 2" tenon, prime painted	9.1 (20)
BKT-11-XX ¹	Tapered pole bracket, 10–13" diameter pole, 1 light, 2" tenon, painted	9.5 (21)
BKT-11-HG	Tapered pole bracket, 10–13" diameter pole, 1 light, 2" tenon, galvanized	9.5 (21)
BKT-11-PP	Tapered pole bracket, 10–13" diameter pole, 1 light, 2" tenon, prime painted	9.5 (21)
BKT-12-XX ¹	Tapered pole bracket, 7–10" diameter pole, 2 light, 2" tenon, painted	13.6 (30)
BKT-12-HG	Tapered pole bracket, 7–10" diameter pole, 2 light, 2" tenon, galvanized	13.6 (30)
BKT-12-PP	Tapered pole bracket, 7–10" diameter pole, 2 light, 2" tenon, prime painted	13.6 (30)
BKT-13-XX ¹	Tapered pole bracket, 10–13" diameter pole, 2 light, 2" tenon, painted	14 (31)
BKT-13-HG	Tapered pole bracket, 10–13" diameter pole, 2 light, 2" tenon, galvanized	14 (31)
BKT-13-PP	Tapered pole bracket, 10–13" diameter pole, 2 light, 2" tenon, prime painted	14 (31)
BKT-14-XX ¹	Tapered pole bracket, 7–10" diameter pole, 3 light, 2" tenon, painted	18.1 (40)
BKT-14-HG	Tapered pole bracket, 7–10" diameter pole, 3 light, 2" tenon, galvanized	18.1 (40)
BKT-14-PP	Tapered pole bracket, 7–10" diameter pole, 3 light, 2" tenon, prime painted	18.1 (40)
BKT-15-XX ¹	Tapered pole bracket, 10–13" diameter pole, 3 light, 2" tenon, painted	18.6 (41)
BKT-15-HG	Tapered pole bracket, 10–13" diameter pole, 3 light, 2" tenon, galvanized	18.6 (41)
BKT-15-PP	Tapered pole bracket, 10–13" diameter pole, 3 light, 2" tenon, prime painted	18.6 (41)
BKT-16-XX ¹	Tapered pole bracket, 7–10" diameter pole, 4 light, 2" tenon, painted	22.7 (50)
BKT-16-HG	Tapered pole bracket, 7–10" diameter pole, 4 light, 2" tenon, galvanized	22.7 (50)
BKT-16-PP	Tapered pole bracket, 7–10" diameter pole, 4 light, 2" tenon, prime painted	22.7 (50)
BKT-17-XX ¹	Tapered pole bracket, 10–13" diameter pole, 4 light, 2" tenon, painted	23.1 (51)
BKT-17-HG	Tapered pole bracket, 10–13" diameter pole, 4 light, 2" tenon, galvanized	23.1 (51)
BKT-17-PP	Tapered pole bracket, 10–13" diameter pole, 4 light, 2" tenon, prime painted	23.1 (51)
BKT-18-XX ¹	Bullhorn, 2U, 2" tenon, 2" slip fitter, painted	9.5 (21)
BKT-18-HG	Bullhorn, 2U, 2" tenon, 2" slip fitter, galvanized	9.5 (21)
BKT-18-PP	Bullhorn, 2U, 2" tenon, 2" slip fitter, prime painted	9.5 (21)
BKT-19-XX ¹	Bullhorn, 2U, 2" tenon, 4" slip fitter, painted	10.4 (23)
BKT-19-HG	Bullhorn, 2U, 2" tenon, 4" slip fitter, galvanized	10.4 (23)
BKT-19-PP	Bullhorn, 2U, 2" tenon, 4" slip fitter, prime painted	10.4 (23)
BKT-20-XX ¹	Bullhorn, 3U, 2" tenon, 2" slip fitter, painted	14.5 (32)
BKT-20-HG	Bullhorn, 3U, 2" tenon, 2" slip fitter, galvanized	14.5 (32)
BKT-20-PP	Bullhorn, 3U, 2" tenon, 2" slip fitter, prime painted	14.5 (32)
BKT-21-XX ¹	Bullhorn, 3U, 2" tenon, 4" slip fitter, painted	16 (35)
BKT-21-HG	Bullhorn, 3U, 2" tenon, 4" slip fitter, galvanized	16 (35)
BKT-21-PP	Bullhorn, 3U, 2" tenon, 4" slip fitter, prime painted	16 (35)
BKT-22-XX ¹	Bullhorn, 3Y, 2" tenon, 2" slip fitter, painted	15.4 (34)
BKT-22-HG	Bullhorn, 3Y, 2" tenon, 2" slip fitter, galvanized	15.4 (34)
BKT-22-PP	Bullhorn, 3Y, 2" tenon, 2" slip fitter, prime painted	15.4 (34)
BKT-23-XX ¹	Bullhorn, 3Y, 2" tenon, 4" slip fitter, painted	16.3 (36)
BKT-23-HG	Bullhorn, 3Y, 2" tenon, 4" slip fitter, galvanized	16.3 (36)
BKT-23-PP	Bullhorn, 3Y, 2" tenon, 4" slip fitter, prime painted	16.3 (36)
BKT-24-XX ¹	Bullhorn, 4U, 2" tenon, 2" slip fitter, painted	20 (44)
BKT-24-HG	Bullhorn, 4U, 2" tenon, 2" slip fitter, galvanized	20 (44)
BKT-24-PP	Bullhorn, 4U, 2" tenon, 2" slip fitter, prime painted	20 (44)
BKT-25-XX ¹	Bullhorn, 4U, 2" tenon, 4" slip fitter, painted	21 (46)
BKT-25-HG	Bullhorn, 4U, 2" tenon, 4" slip fitter, galvanized	21 (46)

¹ Substitute "GR" or "BZ" for "XX" in catalog number to indicate gray or bronze respectively

Catalog Number Reference Guide

Catalog Number	Description	Net Wt kg (lbs) each
BKT-25-PP	Bullhorn, 4U, 2" tenon, 4" slip fitter, prime painted	21 (46)
BKT-26-XX ¹	Bullhorn, 4X, 2" tenon, 2" slip fitter, painted	20 (44)
BKT-26-HG	Bullhorn, 4X, 2" tenon, 2" slip fitter, galvanized	20 (44)
BKT-26-PP	Bullhorn, 4X, 2" tenon, 2" slip fitter, prime painted	20 (44)
BKT-27-XX ¹	Bullhorn, 4X, 2" tenon, 4" slip fitter, painted	21 (46)
BKT-27-HG	Bullhorn, 4X, 2" tenon, 4" slip fitter, galvanized	21 (46)
BKT-27-PP	Bullhorn, 4X, 2" tenon, 4" slip fitter, prime painted	21 (46)
BKT-28-XX ¹	Square bullhorn, 2U, 2" tenon, 2" slip fitter, painted	9.1 (20)
BKT-28-HG	Square bullhorn, 2U, 2" tenon, 2" slip fitter, galvanized	9.1 (20)
BKT-28-PP	Square bullhorn, 2U, 2" tenon, 2" slip fitter, prime painted	9.1 (20)
BKT-29-XX ¹	Square bullhorn, 3Y, 2" tenon, 2" slip fitter, painted	17 (37)
BKT-29-HG	Square bullhorn, 3Y, 2" tenon, 2" slip fitter, galvanized	17 (37)
BKT-29-PP	Square bullhorn, 3Y, 2" tenon, 2" slip fitter, prime painted	17 (37)
BKT-30-XX ¹	Square bullhorn, 4X, 2" tenon, 2" slip fitter, painted	22.7 (50)
BKT-30-HG	Square bullhorn, 4X, 2" tenon, 2" slip fitter, galvanized	22.7 (50)
BKT-30-PP	Square bullhorn, 4X, 2" tenon, 2" slip fitter, prime painted	22.7 (50)
BKT-31-XX ¹	Parapet bracket, 2" tenon, painted	1.8 (4)
BKT-31-HG	Parapet bracket, 2" tenon, galvanized	1.8 (4)
BKT-31-PP	Parapet bracket, 2" tenon, prime painted	1.8 (4)

¹ Substitute "GR" or "BZ" for "XX" in catalog number to indicate gray or bronze respectively

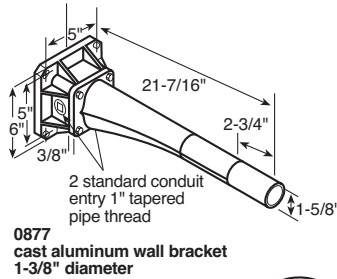

0877
cast aluminum wall bracket
1-3/8" diameter

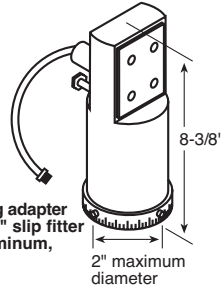

08657
mounting adapter
yoke to 2" slip fitter
cast aluminum,
painted

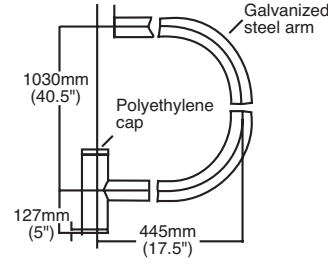

ARM160/170
Shepards Crook

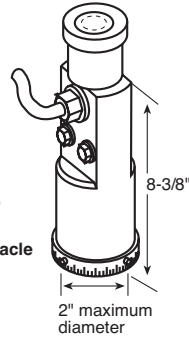

08775
mounting adapter
yoke to 2" slip fitter,
cast aluminum,
painted with NEMA
photocontrol receptacle

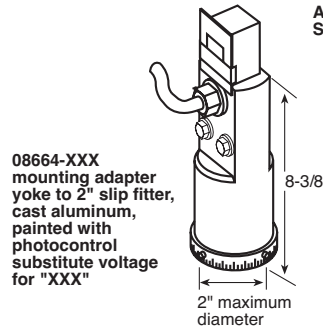

08664-XXX
mounting adapter
yoke to 2" slip fitter,
cast aluminum,
painted with
photocontrol
substitute voltage
for "XXX"

Catalog Number	Description	Net Wt kg (lbs)
08647	Horizontal protractor, horizontal yoke, galvanized steel	.5 (1)
08663-120-GR	Mounting adapter, yoke to 2" slip fitter with photocontrol cast aluminum, gray paint. (Available in 120V only)	.9 (2)
08663-120-BZ	Same as above with bronze paint	.9 (2)
08664-XXX-GR	Mounting adapter, yoke to 2" slip fitter with photocontrol cast aluminum, gray paint, replace "XXX" with voltage (208, 240, 277, 347V only)	.9 (2)
08664-XXX-BZ	Same as above with bronze paint	.9 (2)
08657-GR	Mounting adapter, yoke to 2" slip fitter, cast aluminum, gray paint	.5 (1)
08657-BZ	Mounting adapter, yoke to 2" slip fitter, cast aluminum, bronze paint	.5 (1)
0877	Cast aluminum wall bracket, 1.675" diameter	2.7 (6)
08775-GR	Mounting adapter, yoke to 2" slip fitter with NEMA photocontrol receptacle, cast aluminum, gray paint	.9 (2)
08775-BZ	Same as above with bronze paint	.9 (2)
09128	Horizontal protractor, vertical yoke, cast aluminum	.5 (1)
ARM-160	Shepards Crook galvanized arm for 2" tenon	14.5 (32)
ARM-170	Shepards Crook galvanized arm for 4" tenon	16 (35)
BKT-32-XX ¹	Tenon reducer, 4" to 2", painted	3.6 (8)
BKT-32-HG	Tenon reducer, 4" to 2", galvanized	3.6 (8)
BKT-32-PP	Tenon reducer, 4" to 2", prime painted	3.6 (8)
BKT-33-HG	Square bullhorn 3U, 2" tenon, 2" slip fitter, galvanized	
BKT-33-XX	Square bullhorn 3U, 2" tenon, 2" slip fitter, painted	
BKT-33-PP	Square bullhorn 3U, 2" tenon, 2" slip fitter, prime painted	
BKT-34-HG	Square bullhorn 4U, 2" tenon, 2" slip fitter, galvanized	
BKT-34-XX	Square bullhorn 4U, 2" tenon, 2" slip fitter, painted	
BKT-34-PP	Square bullhorn 4U, 2" tenon, 2" slip fitter, prime painted	

¹ Substitute "GR" or "BZ" for "XX" in catalog number to indicate gray or bronze respectively.