



### Specifications

**Reflectors** - Precision formed, high performance, 95% total reflectance, segmented optics utilizing Alanod MIRO® 4 specular aluminum warranted for 25 years. Reflector optics are available in a wide variety of photometric distributions and spacing criteria.

- Optional heavy gauge reflector material is available for more demanding applications.

**Construction** - Channel, ends and socket brackets are manufactured from 22-gauge cold rolled steel. Riveted and screwed assembly. Tool-less ballast and wiring access.

- Optional all aluminum construction, specify AL and PAF.

**Finish** - Standard high gloss white baked enamel, pretreated with a 5-stage iron phosphate system.

- Optional premium polyester powder coat finish, utilizing a 7-stage pretreatment process of iron phosphate, a non-chromium sealer and a de-ionized water rinse to provide superior adhesion and corrosion resistance. Specify PAF (powder coat after fabrication). Required for aluminum construction.

**Ballasts** - All standard ballasts are electronic, energy saving, thermally protected, Class-P, HPF, non-PCB, Sound Rated A, UL/CSA certified where applicable and comply with © Federal Ballast Law (Public Law 100-357, 1988). Default ballast configuration is for 2-lamp ballasts, except for 1-lamp fixture.

**Electrical** - UL listed wire, rated for required temperatures, used throughout. Lamps are secured with rotary locking lamp sockets for ease of relamping and to reduce lamps disconnecting due to vibration or incidental contact. Luminaire is bi-national listed (UL 1598 and CSA C22.2 No. 250.0-00) and is suitable for damp locations.

**Mounting** - The luminaire may be suspended by chain or cable or may be monopoint mounted with appropriate accessories.

- Accessories are available.

**Lamps** - Factory installed lamps are available in various CRI ratings, temperature colors and rated life.

**Warranty** - Standard 1-year warranty for the fixture. Ballasts carry manufacturer warranties of 3-5 years, depending on the application.



### Catalog Logic

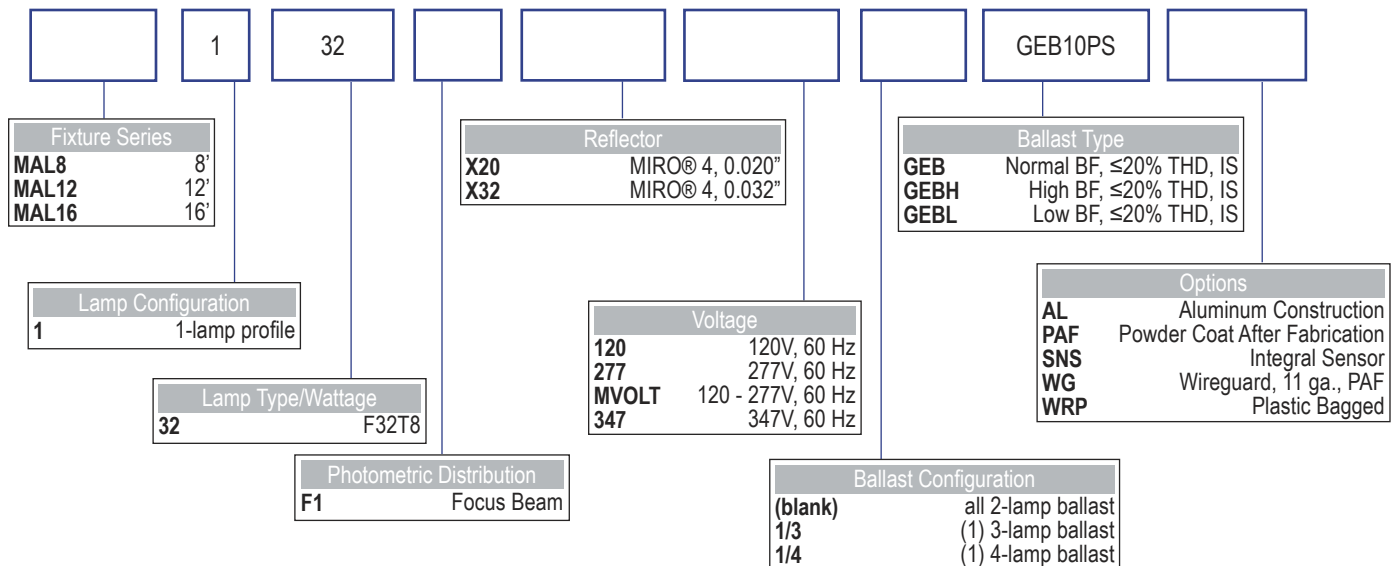

MMAL816T8OS17IS4301





### Applications

MAL luminaires are designed to deliver peak optical performance with maximum efficiency and beam control in industrial, commercial and institutional applications with mounting height up to 35'. Using high performance optics can reduce the number of fixtures required and maximize energy savings.

### Dimensions

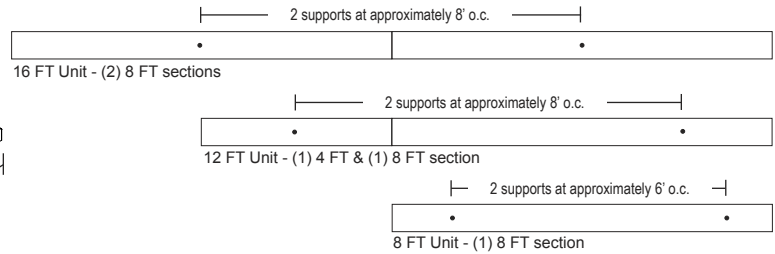
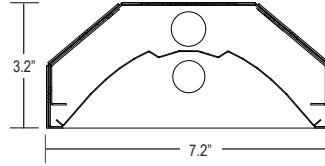
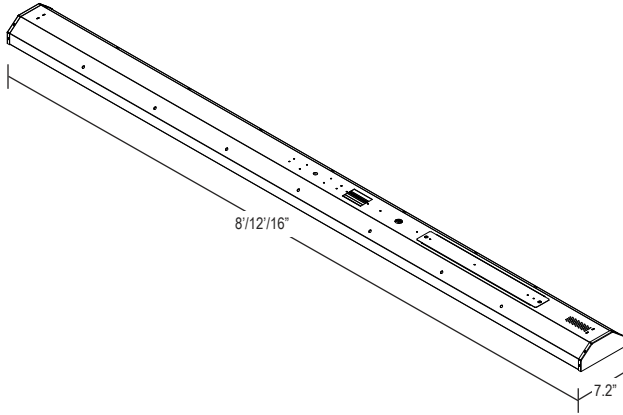

### Features

High fixture efficiency and optical control deliver the peak candlepower needed to produce desired illumination levels from high mounting heights.

- Instant on/off control
- Improved horizontal and vertical illumination
- Long life - up to 20,000 hours
- 90+ Maintained Lumens per watt
- Rigid 2-piece housing for 12FT and 16FT units assembled in the field with 8 screws. Housing requires only 2 supports.

### Additional Options (installed on fixture)

- Battery Pack
- Reloc
- Cord Sets
- Fusing

### Accessories (order separately)

- Aircraft Cable, 1-toggle, 18" legs, 10' **MHYTGB10 \***
- \* 2 hangers/kit

### Photometrics

SC Across Definitions:

Focus = < 0.9 Spacing Criterion (SC)  
Spread = 1.4 to 1.8 Spacing Criterion (SC)

Task = 0.9 to 1.2 Spacing Criterion (SC)  
Broad = > 1.8 Spacing Criterion (SC)

Normal = 1.2 to 1.4 Spacing Criterion

Consult Factory For Photometrics

