

### Specifications

**Reflectors** - Optional X12 Reflector is precision formed, high performance, 95% total reflectance, segmented optics utilizing Alanod MIRO® 4 specular aluminum warranted for 25 years.

**Construction** - Channel, ends and socket brackets are manufactured from 22-gauge cold rolled steel. Tool-less ballast and wiring access.

**Finish** - Standard high gloss white baked enamel, pretreated with a 5-stage iron phosphate system.

**Ballasts** - All standard ballasts are electronic, energy saving, thermally protected, Class-P, HPF, non-PCB, Sound Rated A, UL/CSA certified where applicable and comply with Ⓢ Federal Ballast Law (Public Law 100-357, 1988). Default ballast configuration is for two-lamp ballasts.

**Electrical** - UL listed wire, rated for required temperatures, used throughout. Lamps are secured with rotary locking lamp sockets for ease of relamping and to reduce lamps disconnecting due to vibration or incidental contact. Luminaire is bi-national listed (UL 1598 and CSA C22.2 No. 250.0-00) and is suitable for damp locations.

**Mounting** - The luminaire is designed to be mounted in a standard NEMA G grid ceiling. Integral T-bar safety clips are standard. Drywall grid adapter is available for non-grid applications.

**Warranty** - Standard 1-year warranty for the fixture. Ballasts carry manufacturer warranties of 3-5 years, depending on the application.



### Catalog Logic

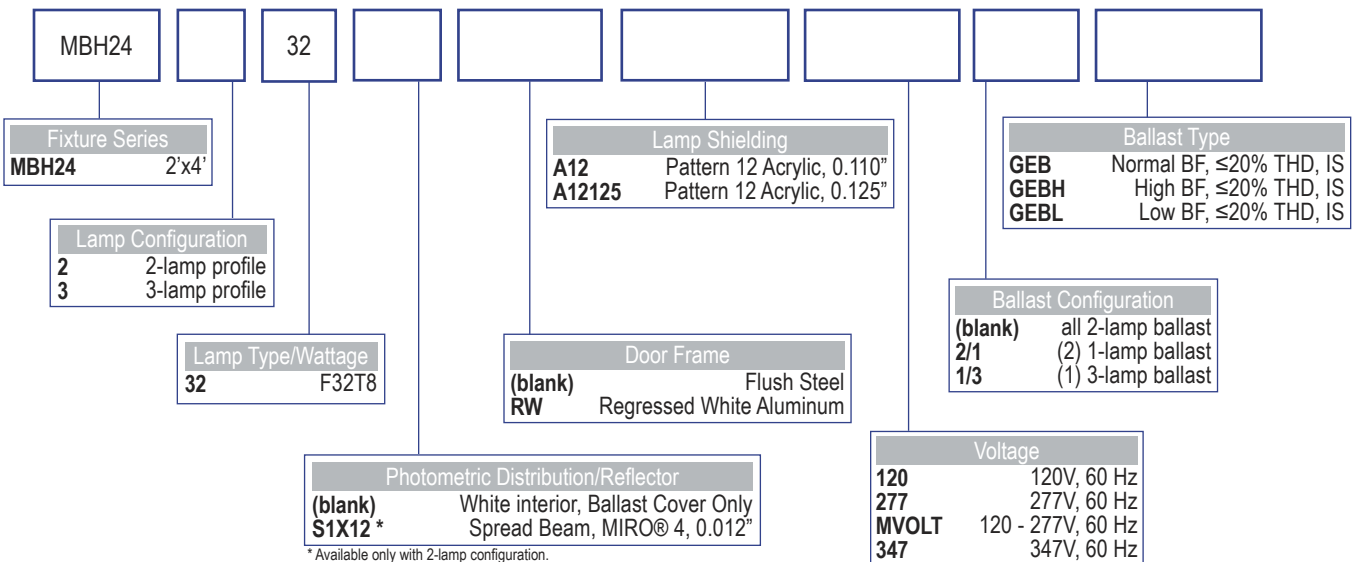

MMBH24T8TL02TF0202



## Applications

MetalOptic's MBH series is a low-profile, static T8 recessed troffer that provides general illumination for recessed applications. Ideal for restricted ceiling plenums, offices, schools, hospitals, and retail interiors.

## Dimensions

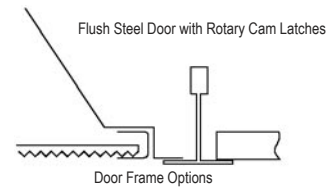
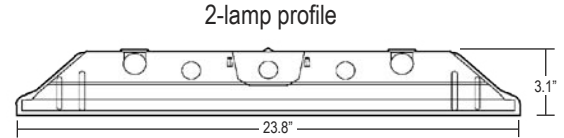
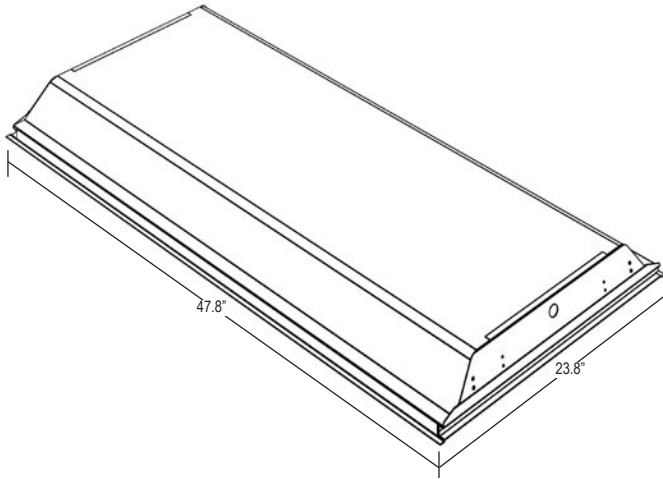

## Features

Innovative low-profile design is optimized around T8 lamps and low-profile electronic ballasts.

- Hemmed sides offer smooth easy handling during installation
- Variety of lenses available for shielding.
- Tandem wiring option available.

## Additional Options (installed on fixture)

- Battery Pack
- Tandem Wiring

## Accessories (order separately)

- Drywall Grid Adapter **DGA24**

## Photometrics

SC Across Definitions:

Focus = < 0.9 Spacing Criterion (SC)

Spread = 1.4 to 1.8 Spacing Criterion (SC)

Task = 0.9 to 1.2 Spacing Criterion (SC)

Broad = > 1.8 Spacing Criterion (SC)

Normal = 1.2 to 1.4 Spacing Criterion

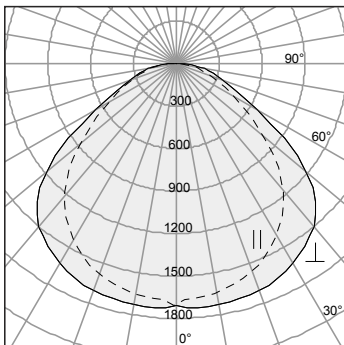

MBH24 2 32 A12  
Test #LTL7424M  
Fixture Efficiency: 81.7%  
SC Across: 1.4, SC Along: 1.2

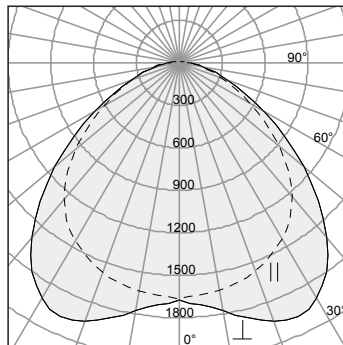

MBH24 2 32 S1X12 A12  
Test #ALP200290M  
Fixture Efficiency: 85.1%  
SC Across: 1.6, SC Along: 1.3

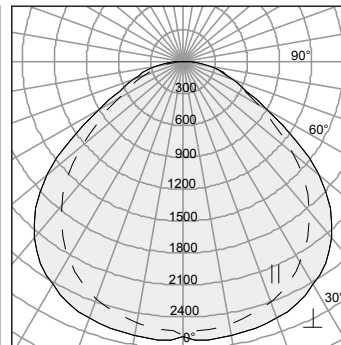

MBH24 3 32 A12  
Test #LTL7421M  
Fixture Efficiency: 80.2%  
SC Across: 1.4, SC Along: 1.2

