

Arm and Wall Mount TAHP24

Catalog Number:

Type:

Project:



Series

Mounting Method

Finish

Sample Catalog no:

Series	Mounting Method	Finish
TAHP24	WMA SPA	DBL
TAHP24	WMA Wall Mount Arm SPA Square Pole Arm	DBL Black DDB Dark Bronze DBNS Copper Brown DCRW Brown Beige DCRU Beige CM Custom Match CS Custom Select RAL colors

Note: See following page for details.

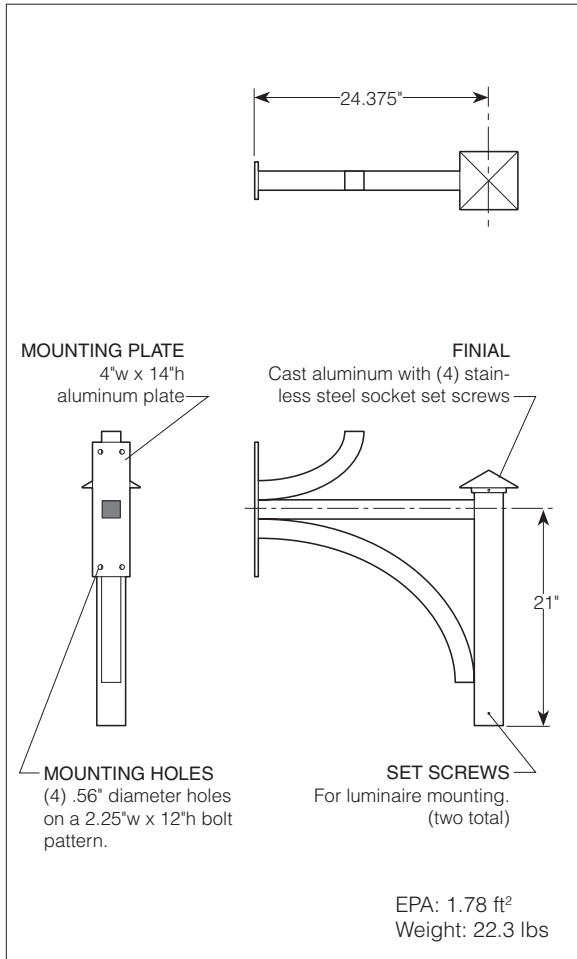

Construction

The arms are extruded aluminum, one-piece construction with a cast aluminum finial. All exposed welds are dressed. All welding is per AWS D1.2/ D1.2M:2003 and all welders are certified. All exposed hardware is tamper resistant stainless steel except for wall mounted hardware which is black zinc plated.

FINISH: The arm has a powder coat finish utilizing a premium TGIC polyester powder. The finish is a three-stage process which consists of drying, powder application and curing. Before coating, the parts are treated with a five-stage pretreatment process, consisting of a heated alkaline cleaner, rinse, phosphate coating, rinse and sealant.

Installation







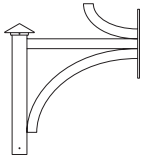



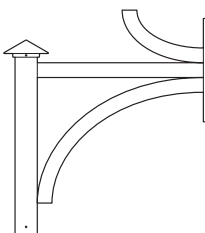







The pole arm mounting plate attaches to the post with four, 3/8-16 hex-head bolts. Center of arm is located at 12" below Pole top. The wall mount arm mounting plate has four, .56" diameter holes for mounting to the wall. It is furnished with two 3/8-16 acorn nuts and washers. Wall studs and junction box are furnished by others. 2" x 4" vertical junction box is recommended. Mounting hardware for wall mount is furnished by others. Arms have a removable finial for wiring access and are furnished with two set screws for luminaire mounting.

WARNING: Tersen reserves the right to modify specification without notice. Any dimensions on this spec sheet is to be assumed as a reference dimension used for informational purposes only.

Arm and Wall Mount TAHP24



ORDERING GUIDE

<p>Series</p>	<p>Tersen Arm - HP series</p> <p><input type="checkbox"/> TAHP24</p> 																		
<p>Mounting Method</p>	<p><input type="checkbox"/> WMA Wall Mount Arm</p> <p><input type="checkbox"/> SPA Square Pole Arm</p>																		
<p>Finish</p>	<table border="0"> <tr> <td><input type="checkbox"/> DBL Black</td> <td><input type="checkbox"/> DDB Dark Bronze</td> <td><input type="checkbox"/> DTG Dark Green</td> <td><input type="checkbox"/> CM Custom Match</td> <td><input type="checkbox"/> CS Custom Select</td> </tr> <tr> <td></td> <td></td> <td></td> <td rowspan="2">This choice requires that a custom powder be manufactured to match a specific color chip provided by the specifier.</td> <td rowspan="2">Tersen offers custom selected RAL powder coat colors. See chart (form 794.3) for cataloged optional colors or contact the factory.</td> </tr> <tr> <td><input type="checkbox"/> DBNS Copper Brown</td> <td><input type="checkbox"/> DCRW Brown Beige</td> <td><input type="checkbox"/> DCRU Beige</td> </tr> <tr> <td></td> <td></td> <td></td> <td></td> <td></td> </tr> </table>	<input type="checkbox"/> DBL Black	<input type="checkbox"/> DDB Dark Bronze	<input type="checkbox"/> DTG Dark Green	<input type="checkbox"/> CM Custom Match	<input type="checkbox"/> CS Custom Select				This choice requires that a custom powder be manufactured to match a specific color chip provided by the specifier.	Tersen offers custom selected RAL powder coat colors. See chart (form 794.3) for cataloged optional colors or contact the factory.	<input type="checkbox"/> DBNS Copper Brown	<input type="checkbox"/> DCRW Brown Beige	<input type="checkbox"/> DCRU Beige					
<input type="checkbox"/> DBL Black	<input type="checkbox"/> DDB Dark Bronze	<input type="checkbox"/> DTG Dark Green	<input type="checkbox"/> CM Custom Match	<input type="checkbox"/> CS Custom Select															
			This choice requires that a custom powder be manufactured to match a specific color chip provided by the specifier.	Tersen offers custom selected RAL powder coat colors. See chart (form 794.3) for cataloged optional colors or contact the factory.															
<input type="checkbox"/> DBNS Copper Brown	<input type="checkbox"/> DCRW Brown Beige	<input type="checkbox"/> DCRU Beige																	
																			

Suggested Luminaires

