

3 Lamp Profile 1x4 Specification Grade Recessed Troffer with Holophane #8224 Lens and Normal Beam White Reflector

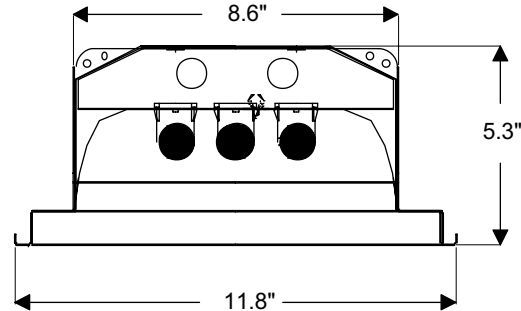

APPLICATIONS

The TG series of grid troffers is a versatile line of specification luminaires with a range of features to customize light output and suit specific needs. Typical applications include offices, schools, hospitals and retail interiors.

FEATURES

The removable reflector is finished with a premium high reflectivity white paint to provide a fixture efficiency of 62.5%.

The 5.3" deep fixture is available with air-handling capability or static, with a regressed aluminum door equipped with spring-loaded cam latches or with a flush steel door and rotary cam latches.

Easy wiring and service are provided by the top-mounted quick access wiring plate, and by the removable ballast cover, which is secured by quarter-turn fasteners.

SPECIFICATIONS

HOUSING : 22 gauge cold rolled steel housing is extremely rigid and fully assembled with rivets. Exterior surfaces are finished with 86% reflectivity high gloss white polyester paint.

REFLECTOR : Made with 90% reflectivity white metal. Reflector profile is computer optimized and precision fabricated.

LENS : Injection-molded Refractive Grid Lens #8224 is made of clear virgin acrylic (see back page for cross-section view).

LAMP HOLDERS : Vossloh rotary-lock lampholders offer superior contact between lamps and electrical connections, and provide long-term lamp service and access.

MOUNTING : The TG troffer is suitable for mounting in NEMA type "G" ceiling systems.

APPROVALS : All TG troffers are UL and CUL listed. City of New York approved fixtures are also available.

TGS14DNH24O43 PHOTOMETRY

Certified by Holophane Corporation, Newark, Ohio.
Photometric test report #48314.

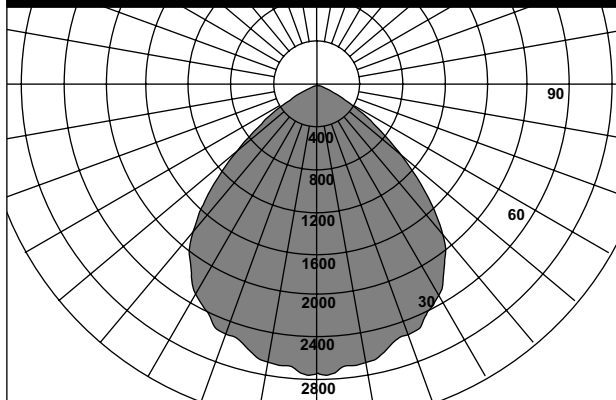





Efficiency = 66.7%, S/MH = 1.3

COEFFICIENTS OF UTILIZATION

CC Wall	80				70				50				30			
	70	50	30	10	70	50	30	10	50	30	10	50	30	10		
RCR 0	.79	.79	.79	.79	.78	.78	.78	.78	.74	.74	.74	.71	.71	.71		
1	.74	.72	.70	.68	.73	.70	.68	.66	.68	.66	.64	.65	.64	.62		
2	.69	.64	.61	.58	.67	.63	.60	.57	.61	.58	.56	.59	.57	.55		
3	.64	.58	.53	.50	.62	.57	.53	.49	.55	.52	.49	.53	.50	.48		
4	.59	.52	.47	.43	.58	.51	.47	.43	.50	.46	.43	.48	.45	.42		
5	.55	.47	.42	.38	.53	.47	.42	.38	.45	.41	.38	.44	.40	.37		
6	.51	.43	.38	.34	.50	.42	.37	.34	.41	.37	.34	.40	.36	.33		
7	.47	.39	.34	.30	.46	.39	.34	.30	.38	.33	.30	.37	.33	.30		
8	.44	.36	.31	.27	.43	.36	.31	.27	.35	.30	.27	.34	.30	.27		
9	.41	.33	.28	.25	.40	.33	.28	.25	.32	.28	.25	.31	.27	.24		
10	.39	.31	.26	.23	.38	.30	.26	.22	.30	.25	.22	.29	.25	.22		

BODY OPTIONS AND LENS DESCRIPTION

Air Feature / Door Frame Option	Fixture Body Gauge	
	22 Ga (std)	20 Ga (NYC)
 Static - No Reveal Flush Steel Door Rotary Cam Latches	S	T
 Static - No Reveal Regressed Aluminum Door Spring Loaded Latches	R	Q
 Air Handling - Black Reveal Regressed Aluminum Door Spring Loaded Latches	A	B
 Static - Black Reveal Regressed Aluminum Door Spring Loaded Latches	N	M

#8224 Lens



Refractive grid lens provides glare and brightness reduction for high visual comfort probabilities. A hexagonal array of hemispherical refractive elements is designed to transmit useful light, while rejecting glare light back into the luminaire to be re-reflected through the lens.

MODELS AVAILABLE

The TG series of recessed troffers is a versatile line of products with a range of features that provide the opportunity to customize light output to suit specific application needs. The fixture code indicates the series, body gauge and door option, size, reflector material type, photometric beam, louver type, lamp quantity and configuration, and ballast type, quantity and voltage. Tandem combinations are also available and are indicated by a number (2, 3 or 4) placed in front of the code below. Please contact the factory for additional information.

Fixture Schedule

Fixture ID

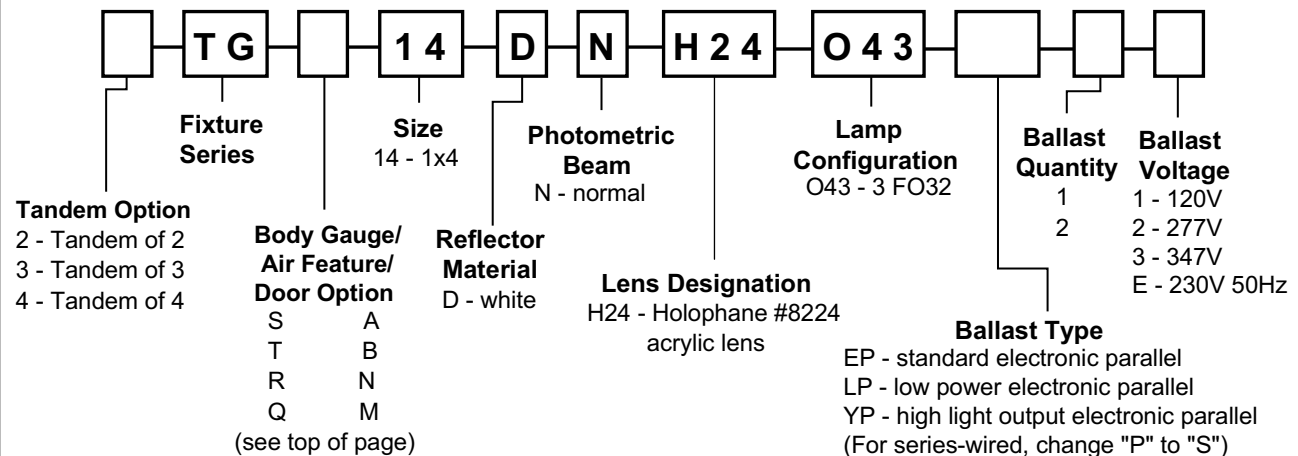

Holophane Corporation, 214 Oakwood Ave.,
Newark, OH 43055 / Holophane Canada, Inc.
294 Walker Drive, Unit #3, Brampton, ON Canada
L6T 4Z2 / Holophane Europe Limited, Bond Ave.,
Milton Keynes MK1 1JG, England.

Contact your local Holophane sales representative for application assistance, computer-aided design and cost studies, and sample units for trial installation. For information on other Holophane products and systems, call the Customer Service Center at 614-345-9631 or fax 614-349-4426. In Canada call 905-793-3111 or fax 905-793-9597.